

SIEMENS



SIMATRIX NEO

Operating manual

Fire Safety & Security Products

Siemens Building Technologies

Data and design subject to change without notice. / Supply subject to availability.

© 2005 Copyright by
Siemens Building Technologies AG

We reserve all rights in this document and in the subject thereof. By acceptance of the document the recipient acknowledges these rights and undertakes not to publish the document nor the subject thereof in full or in part, nor to make them available to any third party without our prior express written authorization, nor to use it for any purpose other than for which it was delivered to him.

| | | |
|----------|--|-----------|
| 1 | General data | 5 |
| 1.1 | General safety instructions | 5 |
| 1.2 | Electromagnetic compatibility (EMC) | 6 |
| 1.3 | Manufacturer's Declaration of Conformity..... | 6 |
| 2 | Ordering information | 7 |
| 3 | Total system with full options | 8 |
| 3.1 | Performance characteristics | 9 |
| 3.2 | Functional description | 11 |
| 3.2.1 | Settings on the CD-ROM | 12 |
| 3.2.1.1 | Basic program | 12 |
| 3.2.1.2 | Alarm program 2 (factory setting) | 13 |
| 3.3 | Interfaces | 14 |
| 3.3.1 | Interfaces for external communication purposes | 15 |
| 3.4 | Peripheral device address allocation | 15 |
| 3.5 | Front display..... | 15 |
| 3.5.1 | Status displays | 15 |
| 3.5.2 | Key allocation..... | 16 |
| 3.5.3 | Indicator lamps..... | 16 |
| 4 | Installation and set-up..... | 17 |
| 4.1 | Safety instructions relating to installation..... | 17 |
| 4.2 | SIMATRIX NEO connections | 18 |
| 4.2.1 | Interfaces and connections | 18 |
| 4.2.2 | Pin allocation for the 4-pin RJ11 telemetry port sockets..... | 19 |
| 4.2.3 | Pin allocation for the 6-pin RJ11 keyboard sockets..... | 20 |
| 4.2.4 | Pin allocation for the COM2/3 and COM4 9-pin connectors..... | 20 |
| 4.2.4.1 | Connecting an external computer to the COM interfaces on the NEO...20 | |
| 4.2.5 | Pin allocation for the 37-pin Sub-D alarm 1 - 16 and alarm 17 – 32 sockets | 22 |
| 4.2.5.1 | Connecting camera head drives (CDCs) | 23 |
| 4.2.5.2 | Connecting the TTY/TTL interface converter (CAC0101)..... | 24 |
| 4.2.5.3 | Connecting the converter for dome cameras (CAC0103)..... | 25 |
| 4.2.5.4 | Connecting alarm sensors | 26 |
| 4.2.6 | SysLink socket allocation..... | 26 |
| 4.2.7 | Pin allocation for the 25-pin Sub-D "Alarm out" socket..... | 27 |
| 4.2.7.1 | Relay switching example | 27 |
| 4.3 | Connecting the video inputs..... | 28 |
| 4.3.1 | Video signal requirements | 28 |
| 4.4 | Connecting the video outputs | 28 |
| 4.5 | Mains connection | 28 |
| 4.6 | Set-up..... | 29 |
| 4.6.1 | Hardware..... | 29 |
| 4.6.2 | Installing the control software and setting device parameters..... | 30 |
| 4.6.3 | Programming the SIMATRIX NEO..... | 31 |
| 4.7 | System extensions | 32 |
| 4.7.1 | Basic unit..... | 32 |
| 4.7.1.1 | Extension to a maximum of 128 video inputs | 32 |
| 4.7.1.2 | Extension up to a maximum of 32 video outputs (SIMNEO-OM) | 33 |
| 4.7.2 | Extension bay..... | 34 |
| 4.7.2.1 | Connecting up the cables (up to 16 video outputs) | 34 |
| 4.7.2.2 | Connecting up the cables (more than 16 video outputs) | 35 |
| 4.7.2.3 | Extension to a maximum of 240 video inputs | 35 |
| 4.7.2.4 | Extension up to a maximum of 32 video outputs (SIMNEO-SOM) | 36 |
| 4.7.3 | Alarm box | 37 |

| | | |
|----------|---|-----------|
| 5 | Operation | 39 |
| 5.1 | Basic program | 41 |
| 5.1.1 | Manual camera image display on a monitor | 41 |
| 5.1.1.1 | Using keyboard 1 (master device) | 41 |
| 5.1.1.2 | Using keyboards 2, 3 and 4 | 41 |
| 5.1.2 | Starting and stopping a camera image sequence | 42 |
| 5.1.2.1 | Using keyboard 1 (master device) | 42 |
| 5.1.2.2 | Using keyboards 2, 3 and 4 | 42 |
| 5.1.3 | Controlling cameras with pan/tilt and lens drives..... | 42 |
| 5.1.4 | Position control..... | 42 |
| 5.1.5 | Camera image sequences | 44 |
| 5.1.5.1 | Revoking password protection for camera image sequences | 44 |
| 5.1.5.2 | Re-establishing password protection | 44 |
| 5.1.5.3 | Camera image sequence using keyboard 1 (master device) | 44 |
| 5.1.5.4 | Camera image sequence using keyboards 2, 3 and 4 | 45 |
| 5.1.6 | Entering or changing positions..... | 46 |
| 5.1.7 | Macros..... | 46 |
| 5.1.7.1 | Recording a macro | 47 |
| 5.1.7.2 | Executing a macro | 47 |
| 5.2 | Alarm program 2 (factory setting) | 47 |
| 5.2.1 | Alarm processing in alarm program 2 | 48 |
| 5.2.1.1 | Revoking password protection for detection group activation | 49 |
| 5.2.1.2 | Re-establishing password protection | 49 |
| 5.2.1.3 | Activating detection groups | 50 |
| 5.2.1.4 | Deactivating detection groups..... | 52 |
| 5.3 | Switching system time to summer/normal time settings | 53 |
| 5.4 | Resetting and initial system boot | 54 |
| 5.4.1 | System reset | 54 |
| 5.4.2 | Rebooting the system (to alarm program 2 factory settings) | 54 |
| 6 | Maintenance | 55 |
| 6.1 | Accessories and ordering information..... | 55 |
| 7 | Appendix | 56 |
| 7.1 | Technical details | 56 |
| 7.2 | Glossary | 57 |
| 7.3 | Summary of basic and alarm program features..... | 58 |

1 General data

1.1 General safety instructions

Safety instructions



Please carefully read the safety instructions and this installation manual before installing and setting up the device.



Warning

Appropriate transportation and storage, professional installation and connection and proper operation and maintenance are prerequisite to the safe and correct function of this device.

Installation, connection, set-up and maintenance may only be performed by qualified personnel. All relevant safety regulations (e.g. DIN VDE) must be observed, with particular attention required for the general installation and safety regulations that apply to work on high tension systems

Only qualified personnel may open the device housing.

Failure to comply may result in death, severe bodily injury or serious damage to property.



Danger

If the outer casing of the video matrix device shows signs of damage, **do not proceed with electrical connection!**

Only connect the device to suitable power sources.

The devices are designed to operate with an earthed three-phase supply, in so-called TN networks (to VDE 0100, section 300 or EN 60950).

Use in IT networks, i.e. networks without an (insulated) earth lead, or impedance-earthed leads, is strictly forbidden. The device is designed for connection to electrical supplies of between 115 and 230 VAC (+10% / -15%) at 50/60 Hz. A separate isolator (switch) must be wired between the device and the electrical supply. The isolator must be installed in an easily accessible place close to the device.

When in operation, a number of components in this device are electrically live. Inexpert handling or operation of this device could therefore result in death, severe bodily harm or damage to property. The device may only be serviced and maintained by suitably qualified personnel.

The device must be isolated from the electrical supply before work starts on it. Ensure that no objects, but particularly objects made of metal, are inserted into the device.

Do not expose the device to fluids or damp.

Please contact our Service hotline if the device no longer operates satisfactorily.



We recommend you contact your local Siemens branch for installation and set-up services and support.

1.2 Electromagnetic compatibility (EMC)

This product has been designed for general CCTV applications in homes, offices or industrial environments. Please check with your supplier before installing this product in medical and or intrinsically safe environments or in an industrial EMC environment.

The product must be installed in accordance with current EMC installation regulations in order to ensure correct function and prevent EMC-related failures.

1.3 Manufacturer's Declaration of Conformity

EU Directive

The following applies for the device described in this manual:

The product satisfies the requirements of EU Directive 89/336/EEC "Electromagnetic Compatibility" and EU Directive 73/23/EEC "Low voltage equipment" in accordance with EN 60950, UL 1950.

| Where applied | Demands in the area of | |
|---|--|-----------------------------------|
| | Device generated interference | Device resistance to interference |
| Industrial and residential applications | EN 55022:1998 class B EN 61000-3-2 A2: 1998 EN 61000-3-3: 1995 | EN 50130-4:1998 |

The EU Declarations of Conformity can be made available to the appropriate authorities by:

Siemens Building Technologies
Fire & Security Products GmbH & Co. oHG

Siemensallee 84

76187 Karlsruhe

2 Ordering information

| Order reference | Short designation | Product | Weight (approx. In kg) |
|--------------------------|-------------------|---|------------------------|
| 2GF2211-8AA | SIMNEO-168 | SIMATRIX NEO 168, complete, 19" base module, 6 HU, PAL model*, incl. CPU, 16 video inputs, 8 video outputs, 32 alarm inputs *Note: NTSC model available on request | 6.5 |
| Extension options | | | |
| 2GF2211-8AB | SIMNEO-EXT | SIMATRIX NEO 19" extension bay, 6 HU, incl. 32 video inputs, 16 video outputs | 6.3 |
| 2GF2211-8CA | SIMNEO-IM | Video input module, 16 extra video inputs | 0.24 |
| 2GF2211-8DA | SIMNEO-OM | Video output module with text overlay, upgrade for the base module with 8 extra video outputs | 0.03 |
| 2GF2211-8DB | SIMNEO-SOM | Video output module without text overlay, 8 extra video output upgrade for the extension bay | 0.03 |
| 2GF2211-8EA | SIMNEO-A128 | Alarm box, 128 alarm inputs, 19" module, 1 HU | 2.50 |
| Accessories | | | |
| 2GF2400-8EA | CKA 3210 | Keyboard without joystick | 0.9 |
| 2GF2400-8EB | CKA 4810 | Keyboard with joystick | 1.05 |
| 2GF2400-8DA | SUT 48 | Keyboard with keys (customer-specified lettering) and joystick | 1.2 |
| 2GF1800-8BE | PSU230-12 | Plug-in power supply unit for the external power supply of the keyboards, 230 V, 50 Hz/DC 12 V, 640 mA, for interior use, complete with 2 m DC cable with open, tinned ends | 0.53 |
| 2GF2207-8AE | SIM-CC3 | - 3 m connection cable for keyboard | |
| 2GF2207-8AF | SIM-CC7 | - 7 m connection cable for keyboard | |
| 2GF2207-8AG | SIM-CC10 | - 10 m connection cable for keyboard | |
| 2GF2208-8AG | SIM-PC | Connection cable for external computers with 9-pin AT connector, 2 m long, for programming the video matrix and loading the alarm program. | |
| 2GF5505-8BA | CAC0101 | TTY/TTL interface converter | 0.1 |
| S24245-F5046-A1 | CAC0103 | DOVE converter | 0.6 |
| 2GF5505-8AK | TTY1X8 | TTY distributor, 8 port | 0.2 |
| S24245-B5015-A1 | CDC0501 | PTZ drive control unit for pan/tilt camera heads without presets | 2.85 |
| S24245-B5017-A1 | CDC0502 | PTZ drive control unit for pan/tilt camera heads with position memory for 64 presets | 2.85 |
| 2GF1708-8EA | CDD2410 | PTZ drive | 7.0 |

3 Total system with full options

The SIMATRIX NEO video matrix allows CCTV systems to be constructed in a compact, modular format.

The SIMATRIX NEO not only allows video signal transfer to keyboards, but also makes it possible to interface to other (alarm processing) systems, etc.

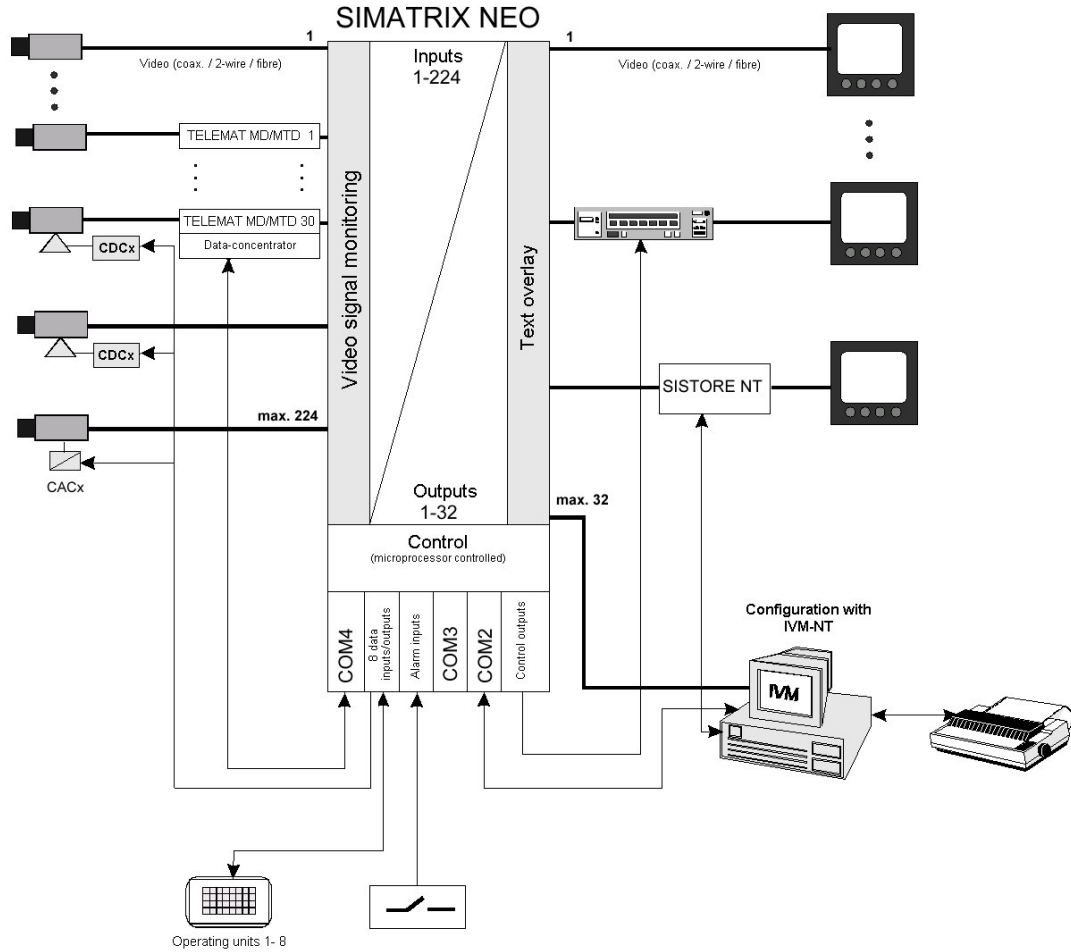

Fig. 1 System configurations with TELEMAT MD/MTD, IVM-NT, SISTORE NT and detection groups (alarms)

3.1 Performance characteristics

The SIMATRIX NEO video matrix consists of a six standard height unit module (6HE), which contains both the system controls and the switching matrix. A maximum of 128 video input signals can be switched at will to a maximum of 32 video outputs (224 video input signals if the extension bay is used).

Video

- SIMATRIX NEO, modular 19 inch system
- Base model: 16 inputs to 8 outputs
Full spec. capacity: 224 inputs to 32 outputs (using the extension bay)
- Number of inputs extendible in steps of 16
Number of outputs extendible in steps of 8
6 standard height unit **M**atrix **C**omponent **T**ray (MCT), extendible to up to a maximum of 128 inputs and 32 outputs
- Video signal input via BNC sockets
- Video signal failure monitor
Like the SIMATRIX SYS, the SIMATRIX NEO features its own built-in video monitoring axis. This means that all the outputs remain available, even when signal monitoring is active.

Control

- Three serial interfaces (RS232) for the connection of external systems, such as IVM-NT, TELEMAT MD/MTD, SISTORE NT, LMS, programming via a PC and secondary control system dialling
- Connection of up to 8 keyboards with freely programmable keys
- 16 serial CL / TTY interfaces for the connection of telemetry devices (CDCs) for cameras with pan/tilt and lens controls
- Connection options for telemetry devices via RS485 interfaces with protocols for CCDA, SCU, Sivis Minidome and Pelco D.
- 32 alarm inputs
- The software supports a maximum of 8 keyboards with freely programmable keys
- CD-ROM with basic program and 6 alarm programs complete with settings, for Windows 98/ME/2000/XP
- Preset positions for camera head controls and dome cameras, which can be called up individually or in sequence
- Remote programming of digital cameras via CAC0101 (dome converter)
- 8 universal open-collector control outputs for controlling external devices
- Relay with 2 voltage-free change-over contacts
- Connection option for a log printer

Options

- Alarm box with 128 alarm inputs
- Extension bay for upgrading to a total of 224 video inputs
- 16-input extra video input extension module
- 8-output extra video output extension module

Operation

- Simple graphical control and visualisation interface using Integrated Video Management (IVM-NT)
- Control via freely programmable keyboards

Programming

The following functions of the SIMATRIX NEO are programmable:

- Time and weekday controlled alarm programs
- Alarm group switching (max. 4 cameras)
- Alarm and home positions of cameras with pan/tilt and lens controls
- Alarm image sequence on one monitor for gap-free recording of alarm images
- Log functionality via IVM-NT/printer
- Password-protected activation or deactivation of detection groups
- On-screen text and time insertion for the keyboards
- Real-time clock (date + time), display on up to 8 monitors
- Camera labels (IBM character set, 12 lines of 24 characters each) per camera
- Group switching (max. 4 cameras)
- Operating stations with switching allocation
- Automatic camera image sequence per video output, can be programmed to start up when the system is switched on
- 32 freely programmable predefined sequences with 32 video inputs per sequence, which can be freely allocated to the video outputs
- Keyboards with freely programmable keys
- Screen menus in German, English and Spanish
- Parameter set can be stored as a data file (library function)
- Up to 4 operator macros

3.2 Functional description

The SIMATRIX NEO video matrix allows CCTV systems with video inputs and outputs to be constructed in a compact, modular format.

The SIMATRIX NEO switches video signals arriving at the video inputs in any user-defined combination to video monitors, image memories, video printers, etc., which are connected to the video outputs. It is possible to dial into the SIMATRIX NEO manually from up to 11 operating stations (a maximum of 8 keyboards and 3 IVM-NT operating stations). Dialling in is also prompted by alarm signals from external contacts or the TELEMAT.

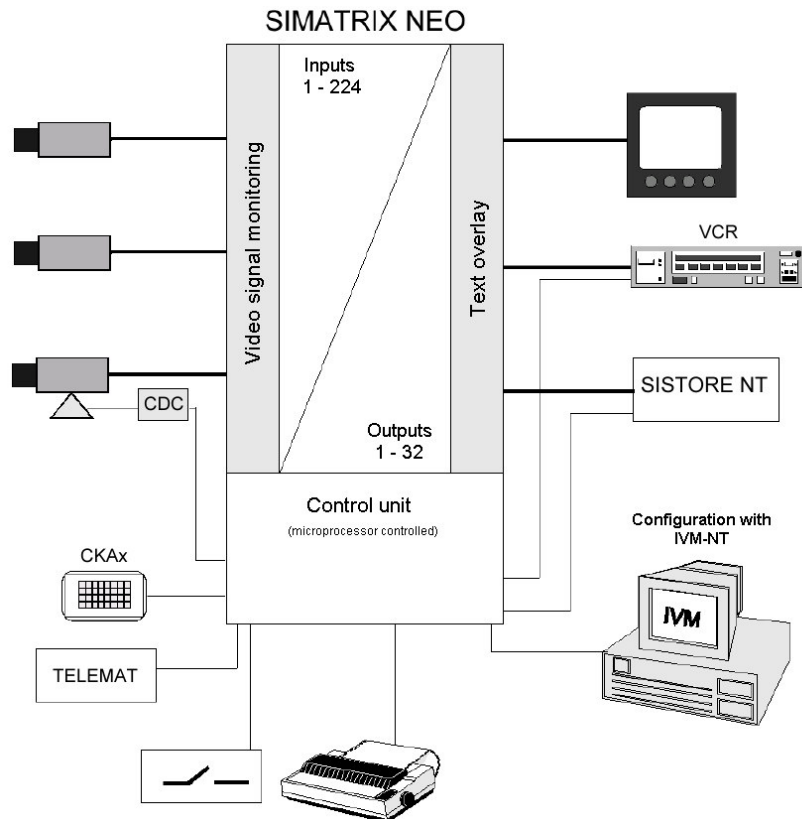

Fig. 2 Video monitoring system with SIMATRIX NEO control centre

The ability to freely program parameters, i.e. user-defined combinations of basic operating software functions, means that the SIMATRIX NEO video matrix can be tailored to suit different system configurations.

In addition to the basic functionality of image switching, the device is also able to remotely operate cameras with pan/tilt and lens drives and select camera position settings.

Date and time overlay, camera identification label overlay and the ability to program automatic image sequences are also possible.

Other essential features are the unit's ability to process incoming alarm signals (detection groups, TELEMAT) by transferring the image from the alarm camera to a previously selected monitor and to switch video recorders and save images to image memories.

The way detection groups are allocated to cameras, the way alarm images are allocated to individual monitors and the choice between group or individual signal transfer are all freely programmable.

3.2.1 Settings on the CD-ROM

The basic program and 6 alarm programs on the CD-ROM supplied with the device provide a level of set-up that allows the system to be put to immediate use.

The programs supplied cover the most common applications. They also make it easier to adjust programming to suit individual needs.



The SIMATRIX NEO is set to use alarm program 2 at the factory. The other alarm programs are described in the control software manual.

3.2.1.1 Basic program

The SIMATRIX NEO can be operated with or without alarm processing. The same basic program is used in both cases.

Number of devices that can be connected

- Cameras: 1 to 48
- CDC: 1 to 48
- Monitors: 1 to 4
- Keyboards: 1 to 4
- IVM-NT operating stations: 1 to 3

The basic program offers the following functionality:

- Keyboard 1 controls monitors 1 to 4
Keyboards 2 to 4 control monitors 2 to 4
- Monitor cycles can be set for all monitors and can be password (PIN code) protected
- Camera designations, the date, the time and camera failure messages can all be displayed on the monitor
- The keyboard can be used to remotely control the most recently switched camera via the SIMATRIX NEO (if the camera is equipped with pan/tilt and lens drives)
- Presets per PTZ-drive (CDC) can be parameterized (Camera with special PTZ, Lens with integrated potis and special CDC necessary)

3.2.1.2 Alarm program 2 (factory setting)



All the alarm programs are described in detail in the programming software manual. An overview of the alarm programs is included in the appendix.

When processing alarms using alarm program 2, the following functions are available in addition to basic unit functionality:

- A detection group can be connected for each camera.
- The 32 alarm inputs are programmed for signal connection in reaction to external contact switching.
- Alarm program 2 displays alarm images on monitors 1, 2 and 4. Monitor 3 is reserved for basic functions.
- In the event of an alarm, alarm image 1 is displayed on monitor 1. A subsequent alarm image is displayed on monitor 2 (see below, schematic representation of the stepped switching display mode)

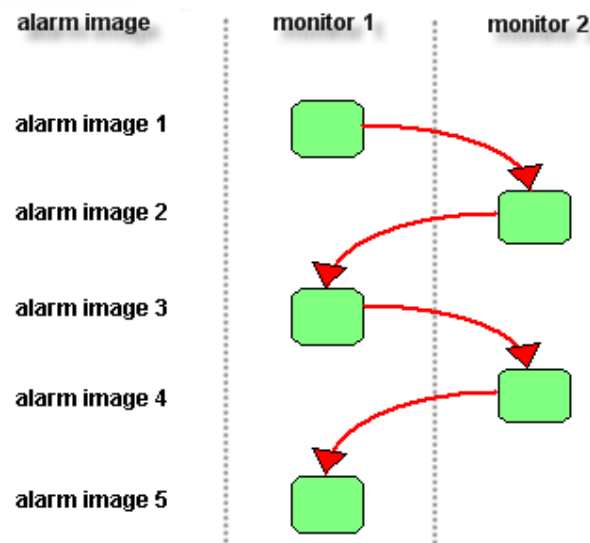

Fig. 3 Schematic representation of the serial display mode (stepped switching)

- The most recent alarm images always appear on monitors 1 and 2. The most recent alarm image successively replaces the oldest alarm image. The most recent alarm image is therefore displayed successively on monitors 1 and 2.
- Each alarm requires manual acknowledgement. The most recent alarms are acknowledged first.
- All the other alarms that have yet to be acknowledged are displayed as an alarm image sequence on monitor 4 to allow gap-free video recording.

3.3 Interfaces

The central processor controls and administers the entire SIMATRIX NEO system with all its video inputs and outputs, detector groups, switch outputs and interfaces to keyboards, CDCs or an external computer.

The control profile depends on the way system parameters have been set (see the SIMATRIX NEO programming manual).



Fig. 4 Interfaces on the back of the device

- | | |
|--|--|
| <p>A 1 COM4: RS232 communication interfaces; data exchange with external computers or systems</p> <p>2 COM2/3: RS232 communication interfaces for data exchange with external computers or systems</p> <p>3 LAN, not yet supported</p> <p>4 SysLink: RS485 system bus for system extension and for connecting the alarm box</p> <p>5 Alarm out 8 x open-collector outputs and master relay</p> <p>6 Alarm 1 - 16/ TTY out For connecting CDCs and detection groups</p> <p>7 Alarm 17 -32/ TTY out For connecting CDCs and detection groups</p> | <p>B Telemetry ports 1 – 4: RS422 connections for dome cameras</p> <p>C Keyboard: for connecting up to 8 keyboards</p> <p>D Video output 1 Vss /75 Ohm: Video outputs</p> <p>E Video input 1 Vss /75 Ohm: Video inputs</p> |
|--|--|

3.3.1 Interfaces for external communication purposes

| Interface designation/type | Qty. | Use | programmable Baud rate |
|--|-------|---|---|
| COM 2, COM 3, COM 4 RS232 | 3 | for programming the SIMATRIX NEO and connecting an external computer. Protocols IVM-NT, TELEMAT MD/MDT, SISTORE NT, log printer, secondary control systems | see programming manual standard setting 19.2 kBaud |
| Keyboard 4-wire ,CL-20mA/TTY interface | 8 | for connecting up to 8 keyboards | see programming manual standard setting 9600 kBaud |
| Alarm 1 - 16/ TTY out Alarm 17 - 32/ TTY out CL-20mA-/TTY interfaces I/O 0-15 | 2 x 8 | For connecting telemetry devices | see programming manual standard setting 2400 kBaud |
| Alarm out Master relay | 1 | 2 voltage-free changeover contacts Group signals for alarms and/or video signal interruption If programmed as normally closed, the relay can also be used to indicate a power failure | |
| Alarm out Open-collector outputs | 8 | For controlling external devices | |

3.4 Peripheral device address allocation

An address must be allocated to all devices, e.g. **keyboards, CDCs and dome cameras.**

Camera head drives, dome cameras and interfaces for camera programming must always be assigned an input. The standard address is identical to the number of the video input to which the remote-drive camera is connected. SIMATRIX NEO programming software allows allocation of other addresses however.

3.5 Front display

3.5.1 Status displays

The front display indicates various device conditions. Values are displayed to an accuracy of $\pm 5\%$ and are to a certain extent dependent on the number of extension modules that have been installed.

These values must be seen as purely indicative and for diagnostic purposes only.

| Status display (examples) | Meaning |
|-------------------------------------|---|
| SIMATRIX Status: waiting for CPU | Device is in the process of starting up |
| SIMATRIX Status: active 09:15 | Device is running and displays system time. |
| SIMATRIX Status: defaults loaded | Device status after initial boot (alarm program 2 loaded) |
| Time/Date 01.02.2005 09:15 | System date and time display |
| last POR before: 014:01:15:00 | Period of time that has elapsed since the device was last turned on or reset (Power On Reset). This can help detect a power failure. Display in ddd:hh:mm:ss (days:hours:minutes:seconds) |
| Software SPU: NeoCtrl 1.00.060 | SPU (Slave Processing Unit) software version |
| Software CPU: 30.11.04 Std | CPU (Control Processing Unit) software version |
| Temp Powersuppl: +45°C | Power supply temperature The power supply could be overloaded if a temperature higher than 70°C is displayed. If this occurs, a qualified electrician should check all system voltages. |
| Temp Mainboard: | Mainboard/internal temperature in the SIMATRIX NEO |

Total system with full options

| Status display (examples) | Meaning |
|------------------------------|---|
| +35 °C | A temperature in excess of 70 °C indicates insufficient housing ventilation. |
| Supply Voltage: U1: 5.9V | Supply voltage on the +6V branch line 6V nominal value. 5V to 7V acceptable range |
| Supply Voltage: U2: -6.1V | Supply voltage on the -6V branch line -6V nominal value. -5V to -7V acceptable range |
| Supply Voltage: U3: 12.5V | Supply voltage on the 12V branch line 12V nominal value. 10V to 17V acceptable range |

A voltage measurement below the acceptable range and close to zero may be indicative of a short-circuit or a system overload. If much higher values appear, a parasitic voltage from an external source in the system may be reaching the device.

3.5.2 Key allocation

The two arrow keys can be used to call up information in a set sequence. The Menu and Enter keys have no function.

3.5.3 Indicator lamps

The indicator lamps (LEDs) on the front panel light up in the following colours to indicate system condition:

- yellow: immediately after switching on, as the system boots up
- green: indicates a successful system start

4 Installation and set-up

The SIMATRIX NEO system is built in modular 19 inch format. The 19 inch component trays have been designed to suit 19 inch frames and cabinets. The side walls of the component trays are perforated to allow good ventilation in the housing (via convection).

When installing component tray modules, make sure that:

- the ventilation holes in the sides are not obstructed in any way
- the maximum supply air temperature of 45 °C is not exceeded in any of the component tray modules

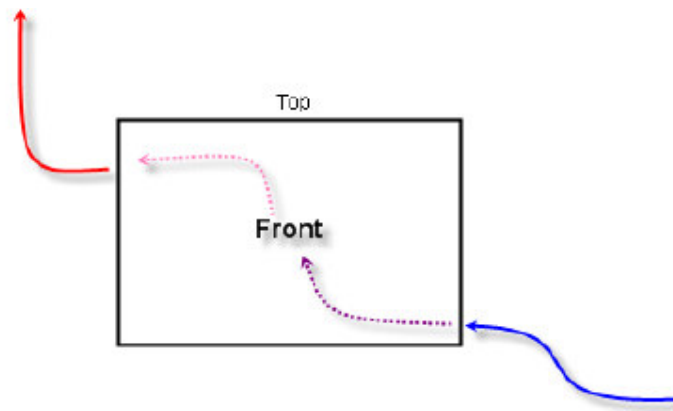

Fig. 5 Air flow through the SIMATRIX NEO

If the component trays in the SIMATRIX NEO generate excessive heat, suitable cooling must be provided (e.g. forced ventilation). The cooling air must be fed from the right-hand side of the housing.

4.1 Safety instructions relating to installation



Danger

Device installation, connection and set-up may only be performed by qualified personnel. All relevant safety regulations must be observed. Particular attention must be paid to the general installation and safety regulations that apply to work on high tension systems (e.g. DIN VDE). Failure to comply may result in death, severe bodily injury or serious damage to property.

We recommend you contact your local Siemens branch for installation and set-up services and support.



Caution

The devices are designed to operate with an earthed three-phase supply, in so-called TN networks (to VDE 0100, section 300 or EN 60950). Use in IT networks, i.e. networks without an (insulated) earth lead, or networks where only impedance-earthed leads are present, is strictly forbidden.

4.2 SIMATRIX NEO connections

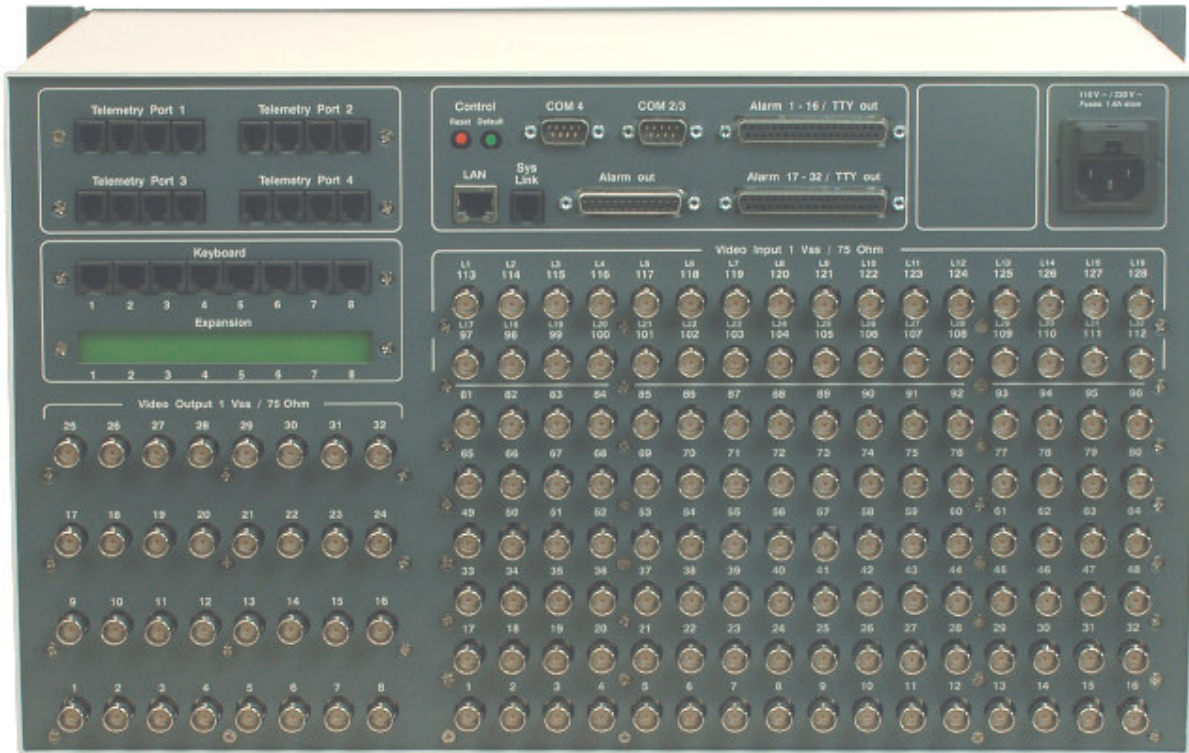

Fig. 6 Rear view of the SIMATRIX NEO (base module)

4.2.1 Interfaces and connections

| Interface | Connection |
|---|---|
| Telemetry port 1 | Connections for dome cameras, 4 x RJ9 , RS422, Protocol: CCDA , Transfer setting: 19k2, 8N1 |
| Telemetry port 2 | Connections for telemetry devices/RS422, 4 x RJ9 Protocol: CCDA , Transfer setting: 2k4, 8E1 |
| Telemetry port 3 | Connections for dome cameras, 4 x RJ9 , RS422, Protocol: Sivis Minidome Transfer setting: 19k2, 8N1 |
| Telemetry port 4 | Connections for dome cameras, 4 x RJ9 , RS422, Protocol: Pelco D Transfer setting: 9k6, 8N1 |
| Keyboard: | 8 RJ12 sockets for connecting keyboards |
| Expansion | for future extension options |
| COM2/3, COM4 | 9-pin Sub-D connectors , RS232 communication interfaces for connecting an external computer |
| ALARM 1-16 / TTY out ALARM 17-32 / TTY out | 37-pin Sub-D socket with 2 x 8 CL-20mA/TTY interfaces for connecting telemetry devices and 2 x 16 alarm inputs for connecting detection groups |
| LAN | not supported, for future network connectivity |
| SysLink | RJ9 socket for connecting extension bay and the alarm box |
| Alarm out | 25-pin Sub-D connector , universal open-collector outputs and relay with two change-over contacts |
| Electrical supply | 115 VAC to 230 VAC (+10% / -15%), 50 Hz to 60 Hz, max 250 mA (at 230 VAC) to 500 mA (at 115 VAC), power requirement 55 VA |
| Video inputs | BNC sockets for video inputs (75 Ω connections, switchable using jumpers) |
| Video outputs | BNC sockets for video outputs |

4.2.2 Pin allocation for the 4-pin RJ11 telemetry port sockets

The "Telemetry Port" sockets allow control of telemetry devices via an RS422 (RS485) interface. Each group of telemetry ports (ports 1 to 4 in each case) is made up of 4 parallel-switched RJ11 modular sockets. Each group is set to support its own protocol at the factory.

| Port | Protocol | Interface parameters |
|------------------|----------------|----------------------|
| Telemetry port 1 | CCDA | 19k2, 8N1 |
| Telemetry port 2 | SCU | 2k4, 8E1 |
| Telemetry port 3 | Sivis Minidome | 19k2, 8N1 |
| Telemetry port 4 | Pelco D | 9k6, 8N1 |

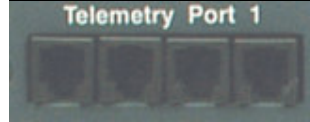

Fig. 7 4-pin RJ11 "Telemetry Port" sockets

| Pin | RS422 function | RS485 function |
|-----|----------------|----------------|
| 1 | +TX | +RX / TX |
| 2 | - TX | -RX / TX |
| 3 | +RX | N.C. |
| 4 | -RX | N.C. |

*not yet available

Tab. 1 Pin allocation for the 4-pin RJ11 "Telemetry Port" sockets

4.2.3 Pin allocation for the 6-pin RJ11 keyboard sockets

The SIMATRIX NEO allows the connection of 8 keyboards via CL/TTY interfaces. The factory transfer setting of 2k4, 8E1 can be changed using the programming software.



Fig. 8 6-pin RJ11 "Keyboard" sockets

| Pin | Function |
|-----|----------|
| 1 | GND |
| 2 | - RX |
| 3 | +RX |
| 4 | - TX |
| 5 | +TX |
| 6 | +12V |

Tab. 2 Pin allocation for the 6-pin RJ11 "Keyboard" sockets

A maximum of 8 keyboards can be connected to the keyboard interfaces. Each keyboard may draw a maximum of 200mA from the SIMATRIX NEO. The total current draw must not exceed 800mA. This means that the SIMATRIX NEO can provide a current supply for a maximum of 4 *SUT48s*, *CKA4810s* or *CKA3210s*. The current supply is protected by an internal self-resetting fuse. Each interface can provide a maximum of 200 mA.

Connection to a keyboard requires the use of a 6-core cable with a maximum length of approx. 1.2 km (0.8 mm core Ø). The NEO is capable of providing the supply up to a maximum distance of 50 m. If an external power supply is used, the maximum permissible distance increases to two kilometres.

Any additional keyboards require the use of an external 12V DC 100 mA, plug-in power supply adapter (e.g. 2GF1800-8BE).

4.2.4 Pin allocation for the COM2/3 and COM4 9-pin connectors

The "COM2/3" and "COM4" connectors are RS232 interfaces. The Y cable supplied with the device must be used to connect to the COM2 and COM3 interfaces.

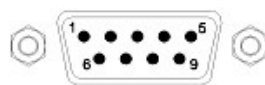

| Pin | COM2/3 connector COM2 function | COM2/3 connector COM3 function | COM4 connector |
|-----|--------------------------------|--------------------------------|----------------|
| 1 | | | |
| 2 | TX COM2 | | TX COM4 |
| 3 | RX COM2 | | RX COM4 |
| 4 | | | |
| 5 | GND | GND | GND |
| 6 | | | |
| 7 | | | |
| 8 | | TX COM3 | |
| 9 | | RX COM3 | |

Tab. 3 Pin allocation for the COM2/3 and COM4 9-pin connectors

4.2.4.1 Connecting an external computer to the COM interfaces on the NEO

The following illustrations show how to connect a computer to the RS232 interface on the SIMATRIX NEO (COM 2, COM 3, COM 4) using a 9-pin or 25-pin Sub-D connector:

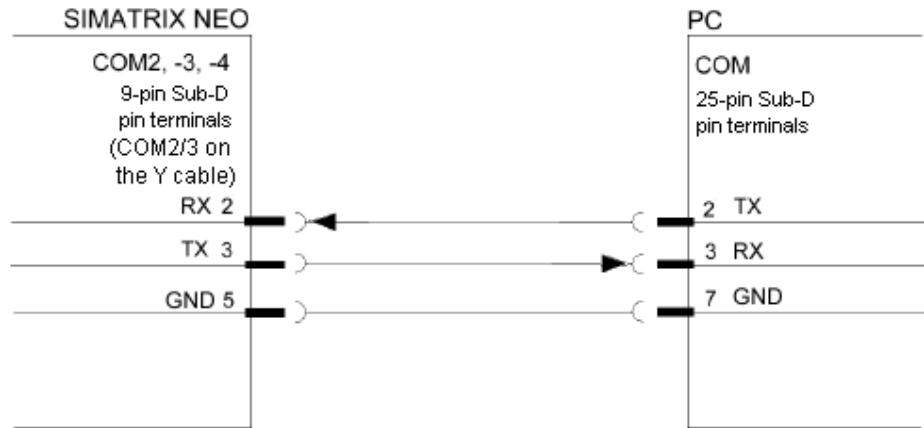

Fig. 9 Connecting an external computer to COM 2, COM 3, COM4 on the SIMATRIX NEO using a **25-pin** connector

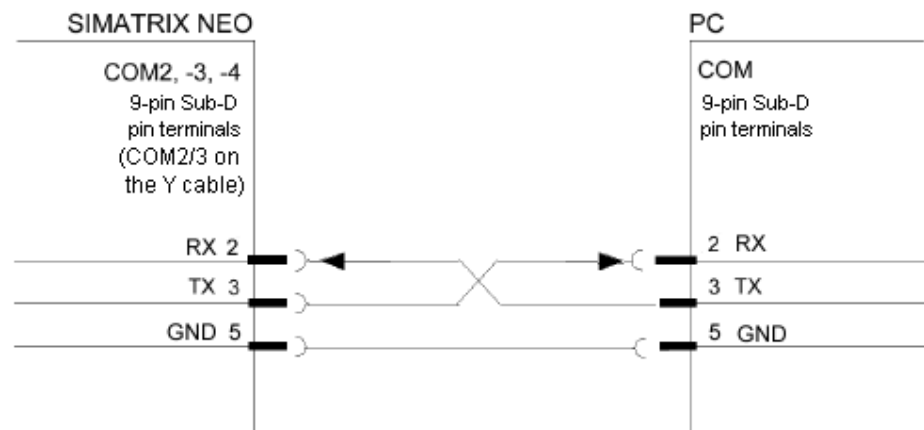

Fig. 10 Connecting an external computer to COM 2, COM 3, COM4 on the SIMATRIX NEO using a **9-pin** connector



Only connect the cables shown in the illustrations!

4.2.5 Pin allocation for the 37-pin Sub-D alarm 1 - 16 and alarm 17 – 32 sockets

The **Alarm 1 - 16 / TTY out** and **Alarm 17 - 32 / TTY out** sockets each have 16 alarm inputs, rated to +5V using internal pull-up resistors. The TTY outputs are set to a data rate of 2400 Baud and use the SCU protocol.

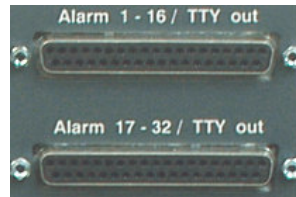

Fig. 11 Alarm 1 - 16 and Alarm 17 – 32



Caution

Do not connect **-TX** to GND, as the negative voltage will short-circuit to GND and place an unnecessary load on the power supply unit.

| Pin | Alarm input function | Pin | TTY function |
|-----|----------------------|-----|--------------|
| 1 | Alarm input 1 | 20 | -TX TTY 1 |
| 2 | Alarm input 2 | 21 | +TX TTY 1 |
| 3 | Alarm input 3 | 22 | -TX TTY 2 |
| 4 | Alarm input 4 | 23 | +TX TTY 2 |
| 5 | Alarm input 5 | 24 | -TX TTY 3 |
| 6 | Alarm input 6 | 25 | +TX TTY 3 |
| 7 | Alarm input 7 | 26 | -TX TTY 4 |
| 8 | Alarm input 8 | 27 | +TX TTY 4 |
| 9 | Alarm input 9 | 28 | -TX TTY 5 |
| 10 | Alarm input 10 | 29 | +TX TTY 5 |
| 11 | Alarm input 11 | 30 | -TX TTY 6 |
| 12 | Alarm input 12 | 31 | +TX TTY 6 |
| 13 | Alarm input 13 | 32 | -TX TTY 7 |
| 14 | Alarm input 14 | 33 | +TX TTY 7 |
| 15 | Alarm input 15 | 34 | -TX TTY 8 |
| 16 | Alarm input 16 | 35 | +TX TTY 8 |
| 17 | GND | 36 | GND |
| 18 | GND | 37 | GND |
| 19 | GND | | |

Tab. 4 Pin allocation for the Alarm 1 -16 37-pin Sub-D socket bar



Technical specifications and allocation identical to the alarm input modules of the SIMATRIX 648.

| Pin | Alarm input function | Pin | TTY function |
|-----|----------------------|-----|--------------|
| 1 | Alarm input 17 | 20 | -TX TTY 9 |
| 2 | Alarm input 18 | 21 | +TX TTY 1 9 |
| 3 | Alarm input 19 | 22 | -TX TTY 10 |
| 4 | Alarm input 20 | 23 | +TX TTY 1 10 |
| 5 | Alarm input 21 | 24 | -TX TTY 11 |
| 6 | Alarm input 22 | 25 | +TX TTY 1 11 |
| 7 | Alarm input 23 | 26 | -TX TTY 12 |
| 8 | Alarm input 24 | 27 | +TX TTY 1 12 |
| 9 | Alarm input 25 | 28 | -TX TTY 13 |
| 10 | Alarm input 26 | 29 | +TX TTY 1 13 |
| 11 | Alarm input 27 | 30 | -TX TTY 14 |
| 12 | Alarm input 28 | 31 | +TX TTY 1 14 |
| 13 | Alarm input 29 | 32 | -TX TTY 15 |
| 14 | Alarm input 30 | 33 | +TX TTY 1 15 |
| 15 | Alarm input 31 | 34 | -TX TTY 16 |
| 16 | Alarm input 32 | 35 | +TX TTY 1 16 |
| 17 | GND | 36 | GND |
| 18 | GND | 37 | GND |
| 19 | GND | | |

Tab. 5 Pin allocation for the Alarm 17 -32 37-pin Sub-D socket bar

4.2.5.1 Connecting camera head drives (CDCs)

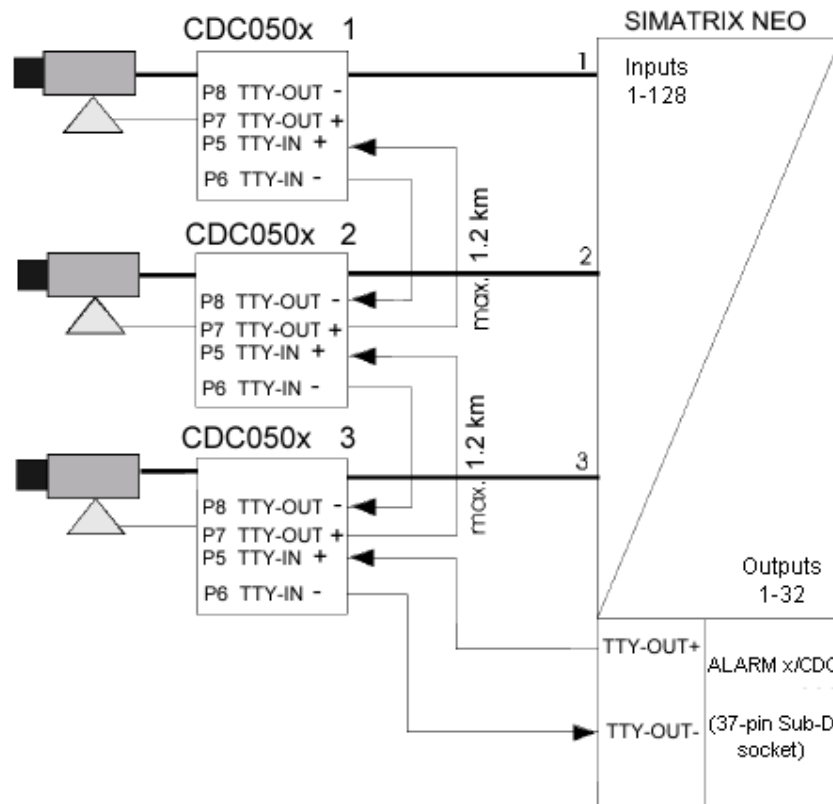

Fig. 12 Connecting camera head drives

4.2.5.2 Connecting the TTY/TTL interface converter (CAC0101)

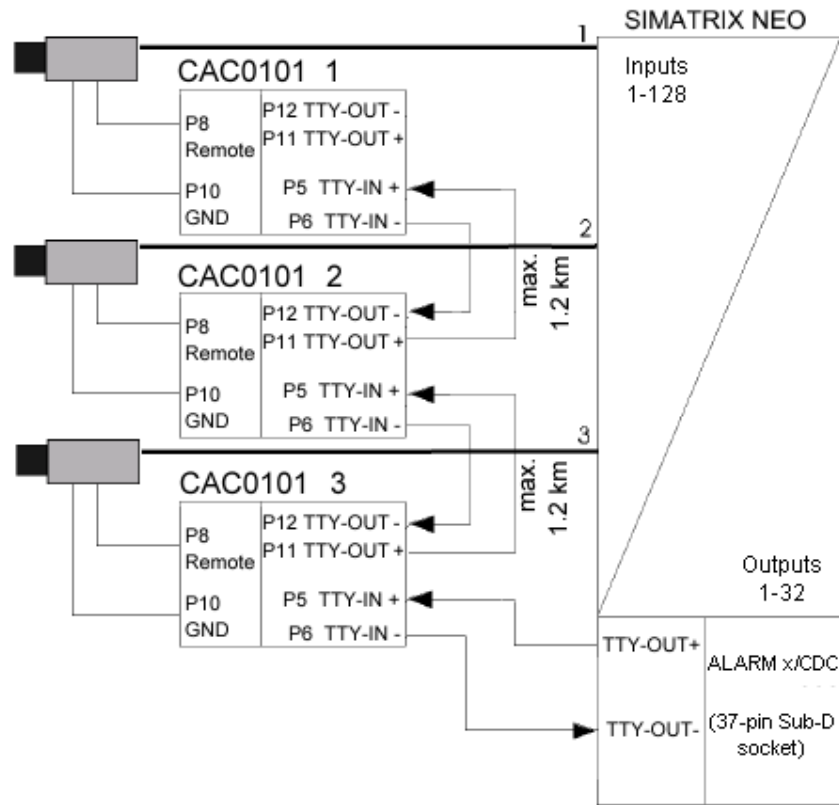

Fig. 13 Connecting interface converters (CAC0101)

4.2.5.3 Connecting the converter for dome cameras (CAC0103)

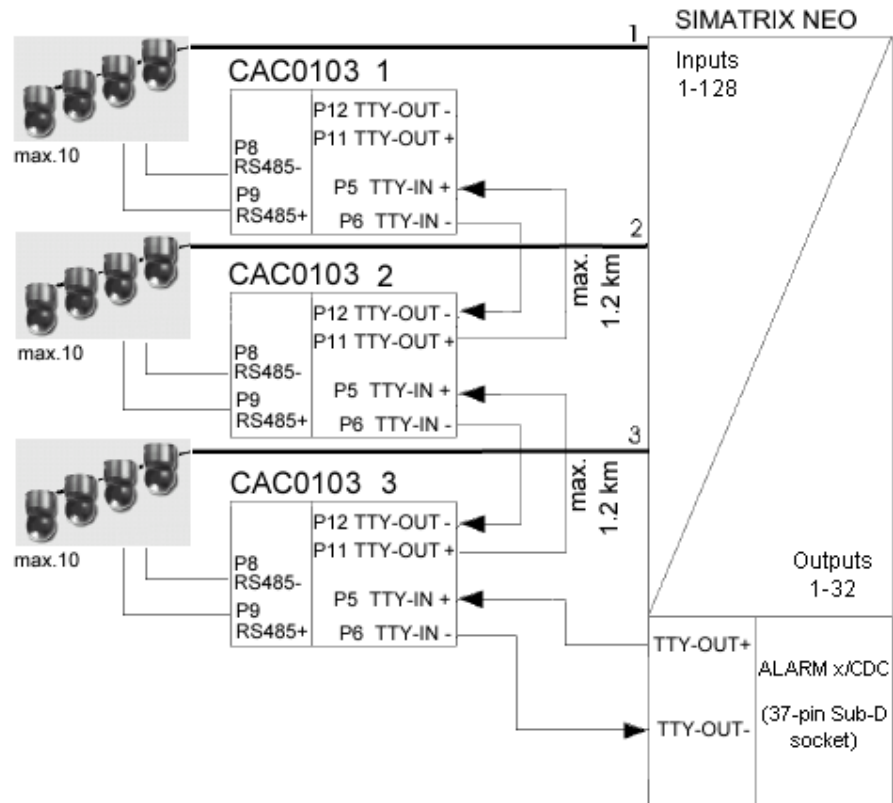

Fig. 14 Connecting interface converters (CAC0103)

4.2.5.4 Connecting alarm sensors

The SIMATRIX NEO is able to process alarm sensors signals, which can be configured as normally closed or normally open contacts.

The schematic below shows how to connect alarm sensor contacts:

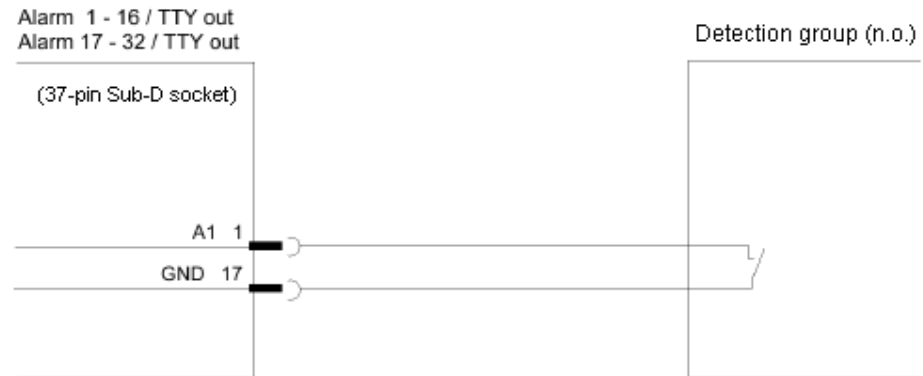

Fig. 15 Connecting a detection group to **Alarm 1 - 16/ TTY out**

The detection group must be no further than 10 m distant from the SIMATRIX NEO.

4.2.6 SysLink socket allocation

The "SysLink" socket allows connection of an extension bay and an alarm box via the serial bus.



Fig. 16 SysLink RJ9 socket

| Pin | Function |
|-----|----------|
| 1 | +TX |
| 2 | -TX |
| 3 | +RX |
| 4 | -RX |

Tab. 6 SysLink RJ9 socket allocation

4.2.7 Pin allocation for the 25-pin Sub-D "Alarm out" socket

The **Alarm out** socket contains 8 open-collector alarm outputs and two voltage-free change-over contacts.



Fig. 17 Sub-D Alarm out socket

| Pin | Function | Pin | Function |
|-----|-----------------------------|-----|---|
| 1 | N.C. | 14 | Open-collector D0 |
| 2 | N.C. | 15 | Open-collector D1 |
| 3 | N.C. | 16 | Open-collector D2 |
| 4 | Relay N.O. contact 1 | 17 | Open-collector D3 |
| 5 | Relay change-over contact 1 | 18 | Open-collector D4 |
| 6 | Relay N.C. contact 1 | 19 | Open-collector D5 |
| 7 | GND | 20 | Open-collector D6 |
| 8 | Relay N.O. contact 2 | 21 | Open-collector D7 |
| 9 | Relay change-over contact 2 | 22 | Common connection for overload diodes (D0-D7) |
| 10 | Relay N.C. contact 2 | 23 | GND (for D0 - D7) |
| 11 | N.C. | 24 | N.C. |
| 12 | N.C. | 25 | N.C. |
| 13 | N.C. | | |

Tab. 7 Sub-D **Alarm out** socket allocation

⁽¹⁾ Common connection of the overload diodes to the 8 open-collector outputs. It is only necessary to wire in this way if switching of inductive loads such as relays is envisaged. Connection must then be made to the plus pole of the voltage supply to the relay.

4.2.7.1 Relay switching example

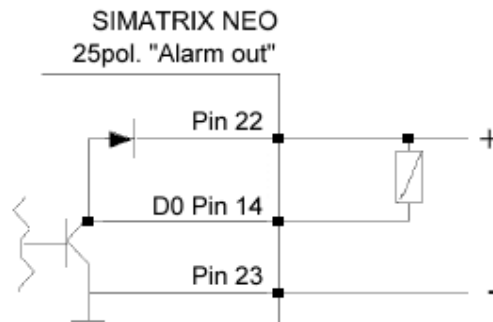

Fig. 18 Relay switching

4.3 Connecting the video inputs

Connect video inputs to the BNC sockets that are labelled **Video Input 1 V_{SS} / 75 Ohm**.

Video sources that are compatible with the SIMATRIX NEO provide a PAL/CCIR video signal at a voltage of 1V_{SS} and an input impedance of 75 Ω.

Up to 16 video sources can be connected to the BNC sockets per input unit.

Each video input terminates in a 75 Ω feed-through jumper. The plug-in jumpers are located on the PCB next to the appropriate BNC socket.

4.3.1 Video signal requirements

The incoming video signal must satisfy the standards defined in the norms (1.0 V_{SS}, 300 mV) for problem-free synchronisation with good image quality and to allow text overlay from the SIMATRIX NEO.



The incoming video signal must at least satisfy the following requirements:

The amplitude of the synchronisation pulse at each video input must be 0.3 V.

The peak amplitude of the video signal at each video input must not exceed 1.0 V_{SS}.

In the case of colour cameras, the burst level at the video input must not exceed 300 mV.



If the video pulse level is too low, a cable equaliser must be wired in at the video source. This device must then be set to boost the signal to the levels specified above.

4.4 Connecting the video outputs

Connect monitors, image recording devices or grabber cards to the BNC sockets that are labelled **Video Output 1 V_{SS} / 75 Ohm**.



If the signal leads are too long, a cable equaliser must be wired in at the monitor.

4.5 Mains connection



Caution

If the outer casing of the video matrix device shows signs of damage, **do not proceed with electrical connection!**

If the local electricity supply lies between 115 and 230 VAC (+10% / -15%) at a frequency of between 50 Hz and 60 Hz, the video matrix can be connected to the mains by plugging the mains connection cable into a wall socket in the supply network. Plug the mains connection cable into the video matrix first. The wall socket must be installed in an easily accessible place close to the SIMATRIX NEO.

4.6 Set-up

4.6.1 Hardware



| | |
|--------------------|--|
| Requirement | TN network (to VDE 0100, section 300 or EN 60950) Voltage range: 115 - 230 VAC (+10% / -15 %) |
|--------------------|--|

- Connect the SIMATRIX NEO to the electrical supply to test it.
Once the system has been connected to the electrical supply, and assuming the device is in good operating order, the following messages will appear in the front display; **waiting for CPU** (start-up message) followed by **active**.
If the system's real-time clock has been deactivated (factory setting), **No Time!** will also appear.
If the system's real-time clock is active, the system time will be displayed.
- To continue installation, you must now unplug the unit at the mains.
- Connect the cameras
- Connect the monitors
- Connect the keyboards
- Connect any other devices
Or, if applicable, connect system extensions and any other devices.
- Connect the control PC
Connect the control PC to COM2 or COM4 using the null-modem cable.
- Connect the SIMATRIX NEO to the electrical supply

Switch on the SIMATRIX NEO; the device will now run through a self-test sequence.

The following two messages will appear in sequence on all the monitors that have been connected:

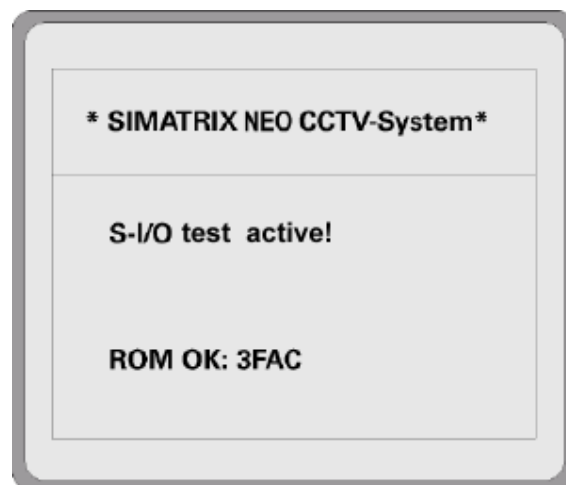

Fig. 19 First message following a system start

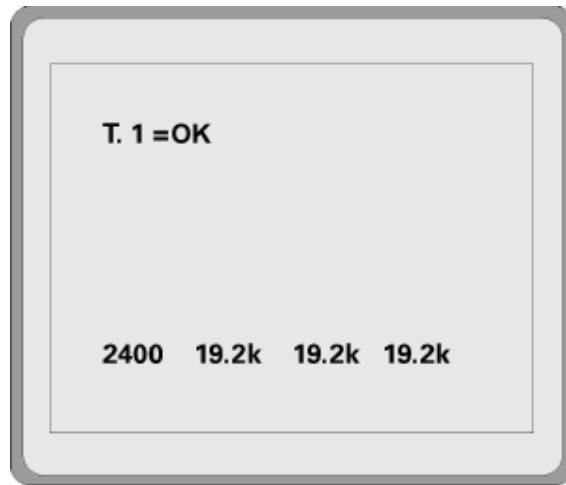

Fig. 20 Second message following a system start (if keyboard 1 is connected)

T.1 =OK

This line means that keyboard 1 is connected.

2400 19.2k 19.2k 19.2k

This line indicates the data exchange rates for COM1 to COM4. In this example, keyboard 1 communicates with the SIMATRIX NEO at 2400 Baud. COM2, COM3 and COM4 are set to 19,200 Baud.

4.6.2 Installing the control software and setting device parameters

- Install the control software
Use the CD supplied with the unit to install the control program. Then start up the control program.
- Set the system time in the SIMATRIX NEO
You must start the system's real-time clock if it is not active (**No Time!** appears in the display), as otherwise a number of important system functions, such as alarm sequencing, will not be available.
Control software: **System real-time clock and OSD clocks** button
- Setting basic parameters
Basic parameters button
Camera and monitor settings
- Setting basic alarm parameters
Basic alarm parameters button
Alarm sensor settings
- Setting camera labels
Camera texts button
- Test cameras, monitors and keyboards
Remote control and message receive button
- Alarm sensor to camera allocation
Alarm lines and camera groups button
- Further programming
If applicable, enter further parameters in order to tailor the function of the SIMATRIX NEO to suit individual operating needs and the rest of the system.
- Make a back-up of the parameter settings and store the back-up close to the system in a safe place.

4.6.3 Programming the SIMATRIX NEO

The SIMATRIX NEO is programmed at the factory to load alarm program 2 as standard. This program allows alarms to be received and processed immediately. The 4 keyboards and the IVM-NT PCs will switch cameras in and out and control cameras with pan/tilt and lens drives.

To load a program or to change a setting in a loaded program, please refer to the instructions in the programming manual.

4.7 System extensions

4.7.1 Basic unit

4.7.1.1 Extension to a maximum of 128 video inputs

The basic unit features 16 video inputs, which are integrated into the mainboard. The first video input module must therefore be inserted into the second slot from the bottom.

- Allocate a number to each additional video input module using the DIP switch on the module to indicate the sequence of the modules from the bottom upwards. The bottom module is number 1, the top module number 7.

| Video input module | DIP switch setting | Video inputs |
|--------------------|--------------------|-------------------------|
| n.a. | n.a. | 1 – 16 on the mainboard |
| 1 | 0001 | 17 – 32 |
| 2 | 0010 | 33 – 48 |
| 3 | 0011 | 49 – 64 |
| 4 | 0100 | 65 – 80 |
| 5 | 0101 | 81 – 96 |
| 6 | 0110 | 97 – 112 |
| 7 | 0111 | 113 – 128 |

Tab. 8 Video input module address allocation on the basic unit

- Each module must be inserted in the lowest available slot.
- Screw the module to the rear cover of the SIMATRIX NEO

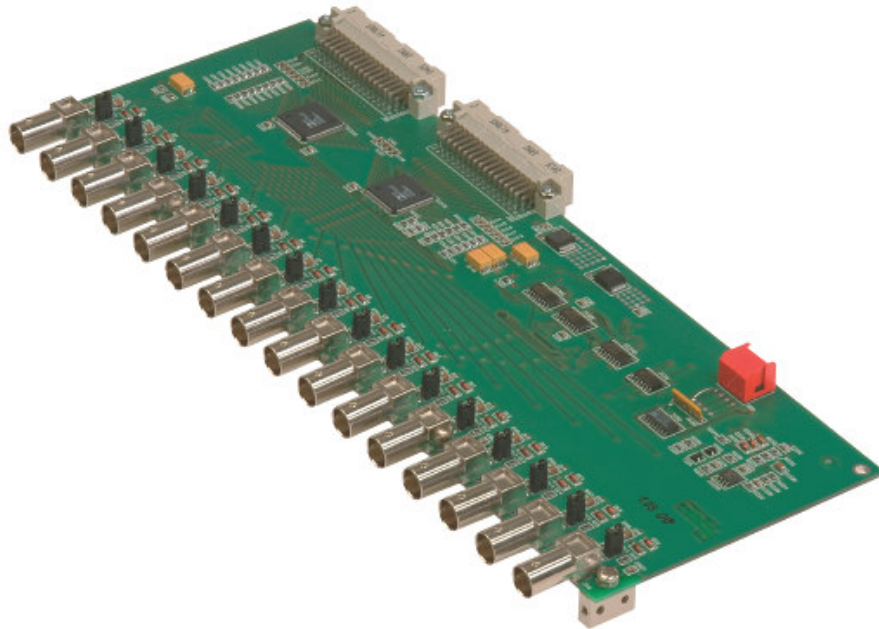

Fig. 21 Video input module



If less than 5 connector slots are in use on the bus boards, insert a blanking plate into the uppermost free slot and screw it in place. This will provide extra reinforcement if the unit ever needs to be moved in the future.

- Finally, use the bus boards to connect all the video input modules and, if applicable, the blanking plate, to the mainboard.

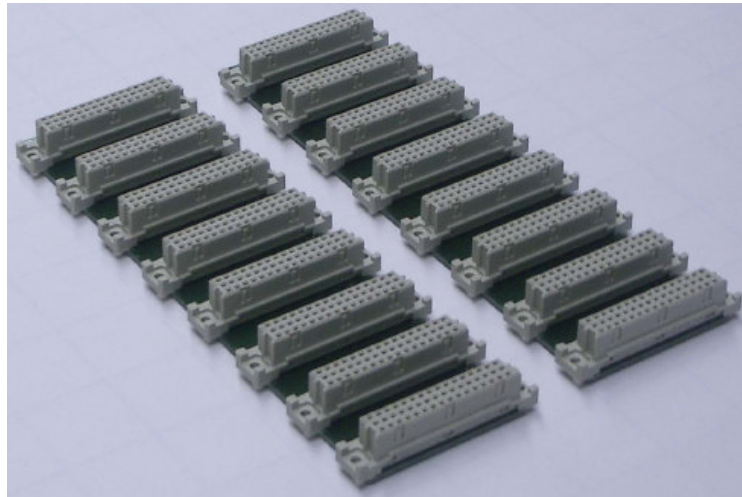

Fig. 22 Bus boards

4.7.1.2 Extension up to a maximum of 32 video outputs (SIMNEO-OM)

- Each extra video output module must be inserted into the lowest available slot.
- Screw the module to the rear cover of the SIMATRIX NEO
- Connect the module to the mainboard using a suitable flat cable.

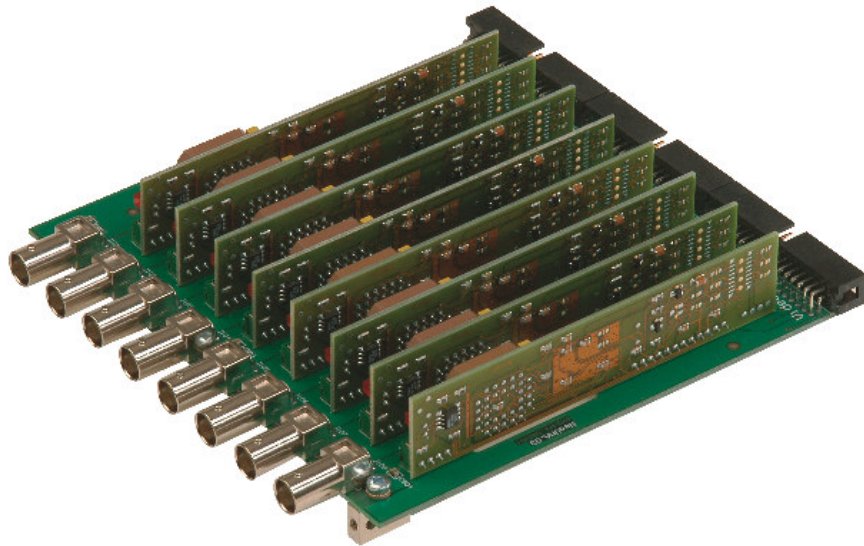

Fig. 23 SIMNEO-OM video output module

4.7.2 Extension bay



The BNC cables required for cascade operation are not included in the standard supply!

The extension bay must be used with systems where more than 128 video inputs are required. The extension bay allows expansion of the SIMATRIX NEO to up to a total of 224 or 240 video inputs in steps of 16 inputs, and up to a total of 32 video outputs in steps of 8 outputs.

| Video outputs in the system | Available video outputs |
|-----------------------------|-------------------------|
| 1 – 16 | 240 |
| 17 – 32 | 224 |

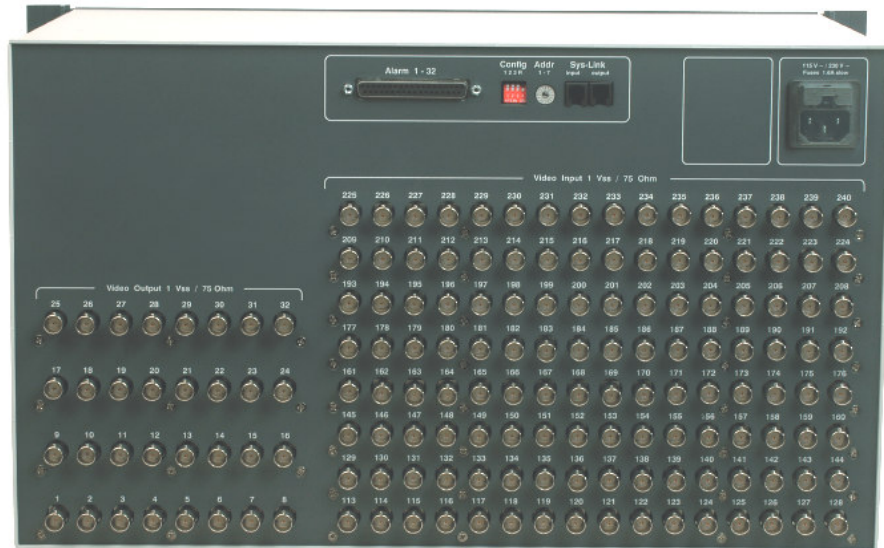

Fig. 24 Rear view of the extension bay

The extension bay features 16 video inputs, which are integrated into the main-board. The video input labels on the rear panel of the extension bay have been designed for a system with a maximum of 16 video outputs.

Systems with more than 16 video outputs

A label sticker supplied with the extension bay can be used for systems with more than 16 video outputs. This label sticker can be used to modify video output numbering to suit this configuration, i.e. the video output number sequence starts at 97 and ends at 224.

4.7.2.1 Connecting up the cables (up to 16 video outputs)

- Connect the **SysLink** socket on the basic unit to the **SysLink Input** socket on the extension bay using the Syslink cable (identifiable by Syslink markings).
- Unplug all the video input cables from video input 113 onward on the basic unit and plug them into the same input numbers on the extension bay
- Connect video outputs 1 to 16 on the extension bay to video outputs L1 to L16 (top row) on the basic unit

4.7.2.2 Connecting up the cables (more than 16 video outputs)

- Use the label sticker provided to correctly number video inputs 113 to 240 on the extension bay
- Connect the **SysLink** socket on the basic unit to the **SysLink Input** socket on the extension bay using the Syslink cable (identifiable by Syslink markings).
- Unplug all the video input cables from video input 97 onward on the basic unit and plug them into the same input numbers on the extension bay
- Connect video outputs 1 to 32 on the extension bay to video outputs L1 to L32 (the two top rows) on the basic unit

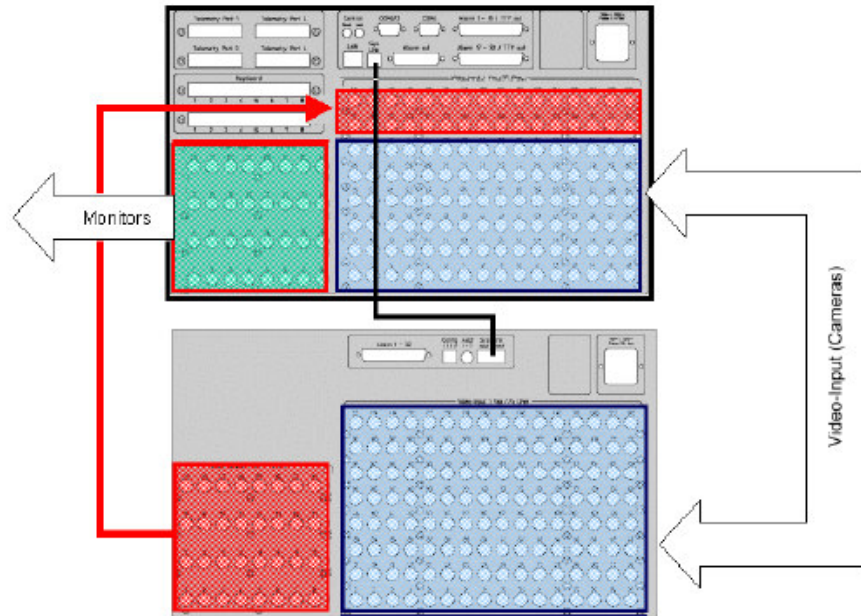

Fig. 25 Circuit diagram for the basic and extension bays

4.7.2.3 Extension to a maximum of 240 video inputs

- Allocate a number to each additional video input module using the DIP switch on the module to indicate the sequence of the modules from the bottom upwards. The bottom module is number 1, the top module number 7.

| Video input module | DIP switch setting | Video inputs in a 16 video output configuration | Video inputs in a 32 video output configuration |
|--------------------|--------------------|---|---|
| n.a. | n.a. | 113 – 128 | 97 – 112 |
| 1 | 0001 | 129 – 144 | 113 – 128 |
| 2 | 0010 | 145 – 160 | 129 – 144 |
| 3 | 0011 | 161 – 176 | 145 – 160 |
| 4 | 0100 | 177 – 192 | 161 – 176 |
| 5 | 0101 | 193 – 208 | 177 – 192 |
| 6 | 0110 | 209 – 224 | 193 – 208 |
| 7 | 0111 | 224 – 240 | 209 – 224 |

Tab. 9 Video input module address allocation on the extension bay

- Each module must be inserted in the lowest available slot.
- Screw the module to the rear cover of the SIMATRIX NEO

4.7.2.4 Extension up to a maximum of 32 video outputs (SIMNEO-SOM)



The number of video output modules in the basic unit (SIMNEO-OM) must correspond to the number of output modules (SIMNEO-SOM) in the extension bay.

- Each extra video output module must be inserted into the lowest available slot.
- Screw the module to the rear cover of the SIMATRIX NEO
- Connect the module to the mainboard using a suitable flat cable.

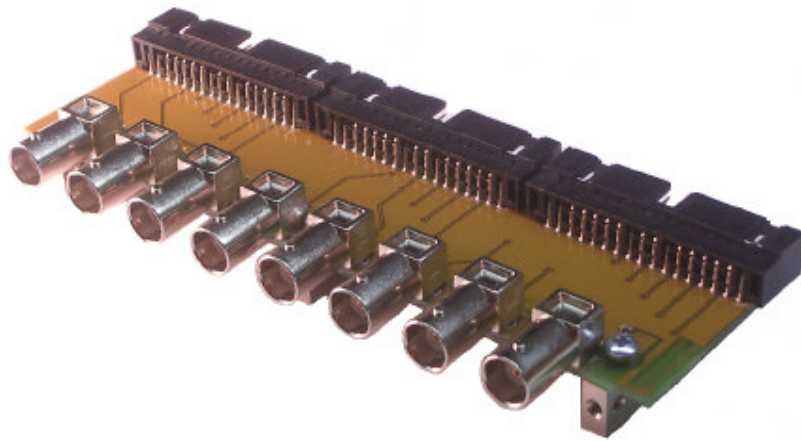

Fig. 26 SIMNEO-SOM video output module

4.7.3 Alarm box

The alarm box extends the SIMATRIX NEO by 128 alarm inputs. It is possible to operate two alarm boxes with a maximum of 240 alarm inputs.

The way the alarm inputs are distributed over the basic unit, the extension bay and the alarm boxes is determined by an operating profile that is configured using the programming software.

| Operating profile | Alarm inputs on the basic unit | Alarm inputs on the extension bay | Alarm inputs on alarm box 1 | Alarm inputs on alarm box 2 |
|---------------------|--------------------------------|-----------------------------------|-----------------------------|-----------------------------|
| Device adr. | ----- | "1" | "2" | "3" |
| Operating profile 1 | 1 – 32 | 33 – 64 | 65 – 192 | 193 – 240 |
| Operating profile 2 | 1 – 32 | none | 33 – 160 | 161 – 240 |
| Operating profile 3 | none | none | 1 – 128 | 129 – 240 |



Fig. 27 Alarm box connections

Pin allocation of the alarm box sockets

The information in the table below applies to the **Alarm input 1 – 32** socket.

| Pin | Function | Pin | Function |
|-----|----------------|-----|----------------|
| 1 | Alarm input 1 | 20 | Alarm input 17 |
| 2 | Alarm input 2 | 21 | Alarm input 18 |
| 3 | Alarm input 3 | 22 | Alarm input 19 |
| 4 | Alarm input 4 | 23 | Alarm input 20 |
| 5 | Alarm input 5 | 24 | Alarm input 21 |
| 6 | Alarm input 6 | 25 | Alarm input 22 |
| 7 | Alarm input 7 | 26 | Alarm input 23 |
| 8 | Alarm input 8 | 27 | Alarm input 24 |
| 9 | Alarm input 9 | 28 | Alarm input 25 |
| 10 | Alarm input 10 | 29 | Alarm input 26 |
| 11 | Alarm input 11 | 30 | Alarm input 27 |
| 12 | Alarm input 12 | 31 | Alarm input 28 |
| 13 | Alarm input 13 | 32 | Alarm input 29 |
| 14 | Alarm input 14 | 33 | Alarm input 30 |
| 15 | Alarm input 15 | 34 | Alarm input 32 |
| 16 | Alarm input 16 | 35 | Alarm input 32 |
| 17 | GND | 36 | GND |
| 18 | GND | 37 | GND |
| 19 | GND | | |

Tab. 10 Pin allocation of the alarm input sockets for operating profile 3

The pin allocation applies to the **Alarm input 33 – 64**, **Alarm input 65 – 96** and **Alarm input 97 – 128** sockets.

| Alarm box / Input | Alarm input, operating profile 1 | Alarm input, operating profile 2 | Alarm input, operating profile 3 |
|-------------------|----------------------------------|----------------------------------|----------------------------------|
| Box 1 / Input 1 | 65 – 96 | 33 – 64 | 1 - 32 |
| Box 1 / Input 2 | 97 – 128 | 65 -96 | 33 – 64 |
| Box 1 / Input 3 | 129 - 160 | 97 - 128 | 65 - 96 |
| Box 1 / Input 4 | 161 -192 | 129 - 160 | 97 - 128 |
| Box 2 / Input 1 | 193 - 224 | 161 -192 | 129 - 160 |
| Box 2 / Input 2 | 225 -240 | 193 - 224 | 161 -192 |
| Box 2 / Input 3 | not used | 225 -240 | 193 - 224 |
| Box 2 / Input 4 | not used | not used | 225 - 240 |

Tab. 11 Allocation of pins and alarm inputs



The technical specifications and allocation of the alarm inputs are identical to the alarm input modules of the SIMATRIX 648.

Config switch

Configuration switch **R** activates an RS422 terminating resistor, used if the alarm box is the last device in the SysLink bus.

Device address switch



Fig. 28 Rotary device address switch

The rotary switch is used to set a device address. At delivery, the switch is set to device address 2. If two alarm boxes are used, device address 3 must be set for the second alarm box.

SysLink connections



Fig. 29 SysLink sockets

The alarm box connects to the basic unit via the SysLink interface. This is an RS422/RS485 four wire, 307.2 kBaud interface.

The alarm box SysLink interface has one input and one output and allows feed-through of the SysLink system to additional devices.

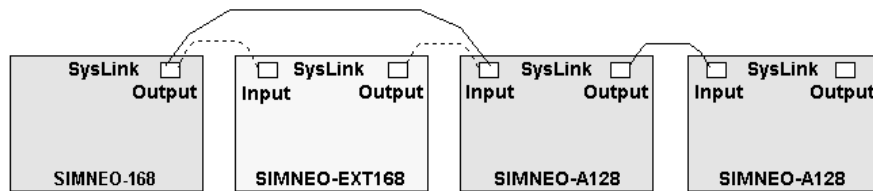

- SIMNEO-168 Basic unit
- SIMNEO-EXT Extension bay. When this unit is not used, the basic unit is connected directly to the first alarm box
- SIMNEO-A128 Alarm box

5 Operation

All the set-up profiles supplied are suitable for the following system configurations:

- IVM-NT systems (on COM2, COM3, COM4)
- 4 keyboards
- 48 Cameras with pan/tilt and lens drives (video inputs 1-48)
- 48 CDCs with position control
- 32 Detection groups

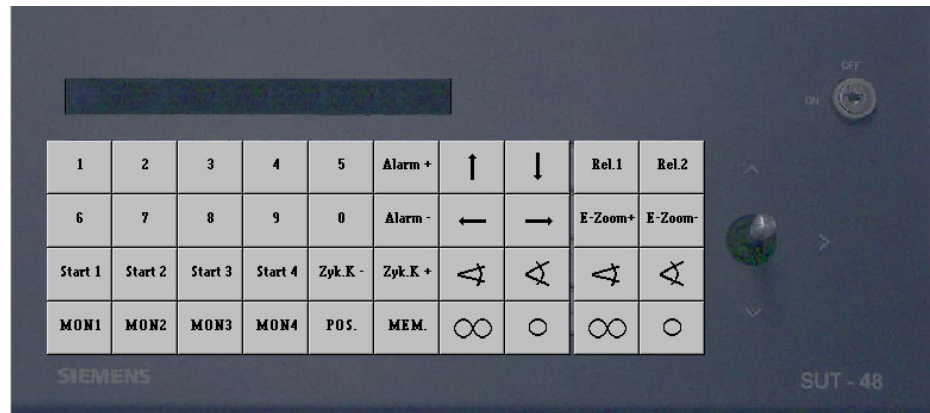

Fig. 30 Keyboard 1 (key layout SUT 48; monitors 1 to 4)



Fig. 31 Keyboard 1 (key layout CKAxX; monitors 1 to 4)

The labels should be removed from any keys that are not required for keyboards 2 to 4.

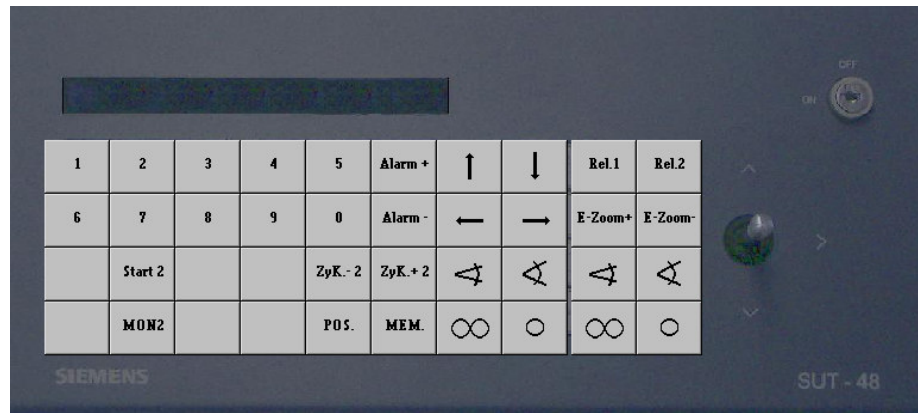

Fig. 32 Keyboard 2 (key layout SUT 48; identical to keyboards 3 to 4; each device controls a single monitor)

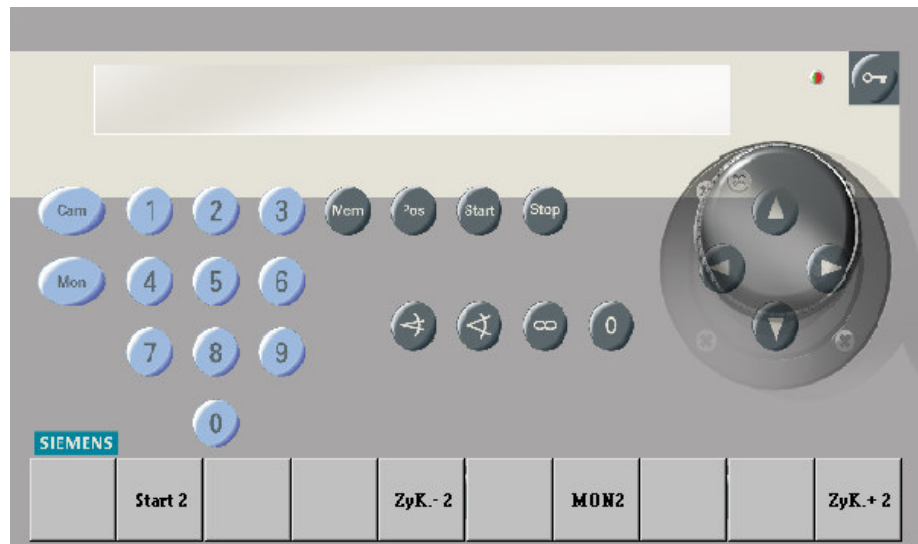

Fig. 33 Keyboard 2 (key layout CKAxX; identical to keyboards 3 to 4; each device controls a single monitor)

5.1 Basic program

No alarm processing takes place in the basic program.

The description of the basic program below also applies to alarm program 2.

The keyboard has a 10-digit keypad and a function pad with 22 grey keys.

Number sequences of up to 3 digits can be entered using the digit keypad.

All the functions are entered using one of the grey function keys.

5.1.1 Manual camera image display on a monitor

5.1.1.1 Using keyboard 1 (master device)

A set key sequence entered via keyboard 1 allows the image from each camera to be switched to each monitor.

Key sequence:

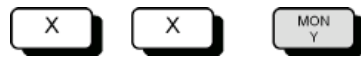

- Enter the camera number using the digit keys(X).
The word **Entry** and the entered camera number will appear on monitor 1.
- Select the monitor of your choice by keying **MON Y**
(e.g. **MON 2** for monitor 2).
The selected monitor will display the image of the selected camera.
The display on monitor 1 will go blank. If no monitor key is pressed, the display on monitor 1 will go blank after about 5 seconds.

5.1.1.2 Using keyboards 2, 3 and 4

When using keyboards 2, 3 and 4, it is only possible to display the image from the chosen camera on the monitor that has been allocated to the keyboard in question.

Key sequence:

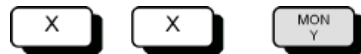

- Enter the camera number using the digit keys(X).
The word **Entry** and the entered camera number will appear on monitor 1.
- Key in **MON Y**.

5.1.2 Starting and stopping a camera image sequence

5.1.2.1 Using keyboard 1 (master device)

Key sequence:



- Start the desired picture cycle by pressing a SEQ key, e.g. **SEQ 2**.
- Stop the sequence by manually switching a camera to this monitor or by pressing the associated monitor key, e.g. **MON 2**. The monitor screen will go blank.

5.1.2.2 Using keyboards 2, 3 and 4

When using keyboards 2, 3 and 4, it is only possible to start a camera sequence that has been allocated to the keyboard in question.

Key sequence:



- Start the picture cycle using the SEQ key. In the case of keyboard 2 this would be **SEQ 2**.
- Stop the sequence by manually switching a camera to this monitor or by pressing the monitor key, e.g. **MON 2**. The monitor screen will go blank.

5.1.3 Controlling cameras with pan/tilt and lens drives

It is possible to remotely control cameras with pan/tilt and lens drives manually. This always applies to the camera that was last selected using the keyboard.

Key sequence:

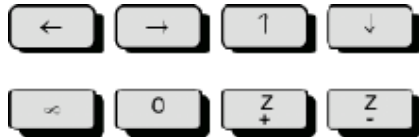

- Use the ← → ↑ ↓ keys or the joystick to tilt the camera horizontally or vertically.
- Adjust the focal length using the **Z+** and **Z-** keys
- Use the **∞** and **0** keys to adjust focus.

5.1.4 Position control

If the camera head drive incorporates a position control facility (e.g. CDC0402 or SCU-302), the camera can be moved to preset positions. In the case of keyboard 1, this applies to the camera that is currently switched to monitor 1. In the case of the other keyboards, this always applies to the camera that was last switched to monitor in question.

Key sequence:

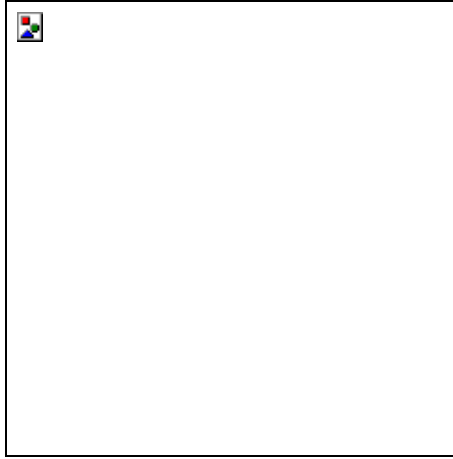

- Enter the number of the desired position using the digit keys(X).
- Press **P**.

5.1.5 Camera image sequences

A password is required to set or change camera sequences (factory setting is 1234, refer to the programming manual to change this setting). The password must be entered to enable storing or changing of camera image sequences. When finished, you must re-establish password protection.

5.1.5.1 Revoking password protection for camera image sequences

Key sequence:



- Enter digit 1 and 2 of the password.
 - Press the **Alarm ON** key
 - Enter digit 3 and 4 of the password.
 - Press the **Alarm ON** key
- The monitor will display the following instruction: **Password**

You can now enter new sequences or make changes.

5.1.5.2 Re-establishing password protection

When you have finished entering a new sequence or making changes, you must re-establish password protection to prevent unauthorised intervention.

Key sequence:



- Enter **254**
 - Press the **Alarm ON** key
- The on-screen instruction, **Password**, disappears.

5.1.5.3 Camera image sequence using keyboard 1 (master device)

Camera image sequences for monitors 1 to 4 can be stored using keyboard 1.

Key sequence:



- Enter the camera number using the digit keys (X).
- Select the monitor of your choice by keying **MON Y** (e.g. **MON 2** for monitor 2).
The selected monitor will display the image of the selected camera.
- Enter the number of the monitor (Y) where you want to display the camera image sequence.
- Add the camera to the chosen camera image sequence by keying **SEQ + C**

Deleting a camera from a camera image sequence

Key sequence:



- Enter the camera number using the digit keys (X).
- Select the monitor where you want to display the camera image sequence by keying **MON Y** (e.g. **MON 2** for monitor 2).
- Delete the camera from the chosen sequence by keying **SEQ - C**.

5.1.5.4 Camera image sequence using keyboards 2, 3 and 4

When using keyboards 2, 3, 4, it is only possible to enter or change a camera image sequence for the current monitor.

Key sequence:



- Enter the camera number using the digit keys (X).
- Key in **MON Y**
(e.g. **MON 2** for monitor 2).
The camera image from the chosen camera appears on the monitor.
- Enter the number of the monitor (Y), to which the keyboard has been allocated (e.g. **2** for monitor 2).
- Add the camera to the chosen camera image sequence using the **SEQ +** key

Deleting a camera from a camera image sequence

Key sequence:



- Enter the camera number using the digit keys(X).
- Key in **MON Y**
(e.g. **MON 2** for monitor 2).
- Delete the camera from the chosen sequence using the **SEQ -** key.

5.1.6 Entering or changing positions

Position control of the camera panning drives and lens drives is only possible if each panning drive and lens drive has been initialised during initial system set-up (see programming manual).

The keyboards can be used as follows to set, change and store positions for cameras with pan/tilt drives and with lens drives:

- Keyboard 1: for the camera switched to monitor 1
- Keyboards 2, 3 and 4: for the camera that was last switched to the monitor

Key sequence:



- Move the panning drive and lens drive of the selected camera to the desired position by pressing the ← → ↑ ↓ Z- Z+ 0 ∞ keys.
- Enter the position number using the digit keys (Z).
- Press **S** to store the position.

This saves the position for the corresponding camera head drive to memory, allowing it to be retrieved whenever required (see chapter –).

5.1.7 Macros

The SIMATRIX NEO can store four macros, which can then be recorded using a keyboard. The stored macros can be executed by any keyboard in the system that has been programmed accordingly. Each macro can include up to 60 keyboard actions, allowing automation of complex special functions.



Commands for camera head drives cannot be used in macros.

The programming software is used to configure whether a key on the keyboard executes just one macro, or whether all four macros can be recorded and executed using the same key. Please refer to the description of the configuration program for more details relating to macro programming.



The exact functionality of a macro depends on the key configuration of the keyboard where the macro was originally recorded.

If the configuration of any of keys used in the macro is changed after initial macro programming, the functions executed by the macro will also change.

We therefore recommend that macros are only recorded and executed on a dedicated keyboard.

5.1.7.1 Recording a macro

Preset numbers, 101, 102, 103 and 104, are used to record and call up macros. When reprogramming takes place under the same macro number, the previous macro is overwritten. The same key sequence is always used to start up and end a macro recording.

- Starting up the macro recorder. Key sequence for macro 3:



- Now execute the macro, which consists of up to 60 keyboard actions. The 61st action will break off programming and shut off the macro recorder)

- End recording of macro 3:



5.1.7.2 Executing a macro



When executing macros, we recommend switching off the keyboard's OSD text overlay. This speeds up macro processing and prevents the appearance of irritating text overlay.

- Depending on the way your have configured macro operation, either press the predefined macro hotkey or enter the macro number and press **Macro**

5.2 Alarm program 2 (factory setting)



The same operating options offered by the basic program are also available in the alarm programs.

Alarm program 2 also offers the operating options that have been described for the basic program. Alarm processing is offered as an addition feature. A detection group feature is included for each camera input.

This program allows sequencing of 48 cameras, which are each identified as the next in sequence camera relative to a previous camera

Example:

Camera that triggers the alarm: camera 15
next in sequence camera: camera 14).

The configuration details must be changed as indicated in the programming manual if less than 48 cameras are installed or other sequences are required.

Detection groups can be activated and deactivated using a password.

The detection group table can be retrieved at any time by pressing the **Alarm ON** key.

The table disappears when the **Alarm ON** key is pressed again.

If the SIMATRIX NEO has been installed in combination with the Siemens TELEMAT video alarm system, the zone from which the alarm originates will be highlighted in the alarm image when an alarm is triggered. Acknowledging an alarm will then also reset the TELEMAT system.

5.2.1 Alarm processing in alarm program 2

Alarm can be processed as follows:

- When an alarm is triggered, the alarm image (camera image of the zone from which the alarm originates) appears on monitors 1 and 4 along with the text **ALARM!**.
- The alarm can be acknowledged (turned off) by keying **MON 1**. The original images will now appear on the monitors.
- if a second alarm is triggered before the first alarm can be acknowledged, the second alarm image will appear on monitor 2.
- Each additional alarm image will overwrite one of the alarm images on display, so that monitors 1 and 2 always display the most recent two alarm images.
- If two or more alarm images are active simultaneously, they will all appear as an alarm image sequence on monitor 4.

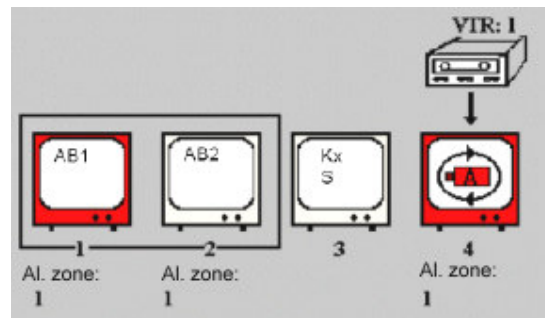

Fig. 34 Display of two alarm images

| | |
|---------|---|
| AB | Alarm image |
| AB1-AB2 | Alarm image display on monitors 1 and 2 |
| Kx S | Selected camera image sequence on monitor 3 |
| A | Alarm image sequence on monitor 4 |
| VTR: 1 | Video recorder for gap-free alarm image recording from output 4 |

- The alarm displays on monitors 1 and 2 can be acknowledged. The oldest, next in-sequence image will then appear on the monitor where the image has just been acknowledged. When this alarm image is acknowledged, the next oldest alarm image appears, etc.
- Monitor 3 is still available to switch cameras manually or to play the automatic image sequence.
- A video recorder connected to output 4 starts up automatically at the first alarm signal. It records the images that appear on monitor 4.
- The recorder stops when the last alarm is acknowledged or switches to the pre-set long-term recording setting.

5.2.1.1 Revoking password protection for detection group activation

Key sequence:



- Enter digit 1 and 2 of the password.
 - Press the **Alarm ON** key
 - Enter digit 3 and 4 of the password.
 - Press the **Alarm ON** key
- The monitor will display the following instruction: **Password**

You can now make changes.

5.2.1.2 Re-establishing password protection

When you have finished making changes, you must re-establish password protection to prevent unauthorised intervention.

Key sequence:



- Enter **254**
 - Press the **Alarm ON** key
- The on-screen instruction, **Password**, disappears.

5.2.1.3 Activating detection groups

Key sequence:



- Press the **Alarm ON** key

The following alarm input table appears on the monitor (example):

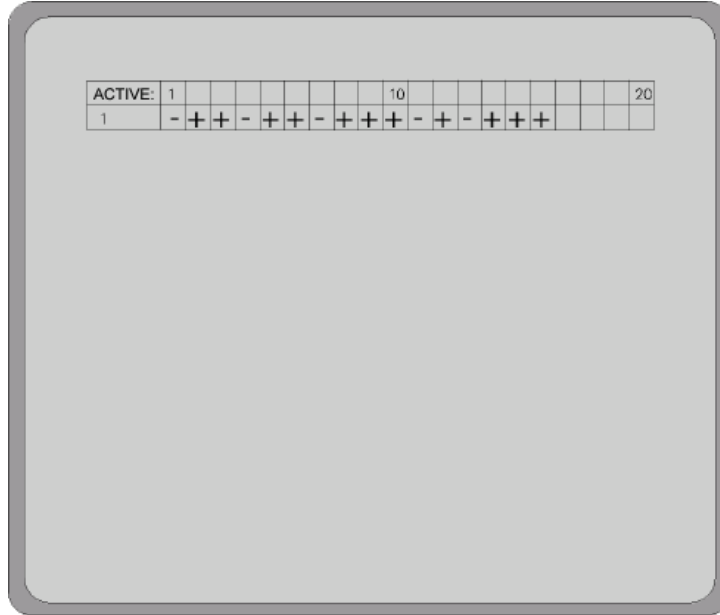

Fig. 35 Detection groups table

Key sequence:



- Enter the number of the detection group that you want to activate.
The word Entry and the entered number will appear on the monitor.
- Press the **Alarm ON** key
The monitor displays the table with a plus sign at the side of the active alarm input.

Activating all alarm inputs simultaneously

- Enter **255** to simultaneously activate all the alarm inputs
 - Press the **Alarm ON** key
- The following table appears on the monitor:



Fig. 36 Detection groups table: all groups activated

5.2.1.4 Deactivating detection groups

Key sequence:



- Press the **Alarm ON** key

The following alarm input table appears on the monitor (example):

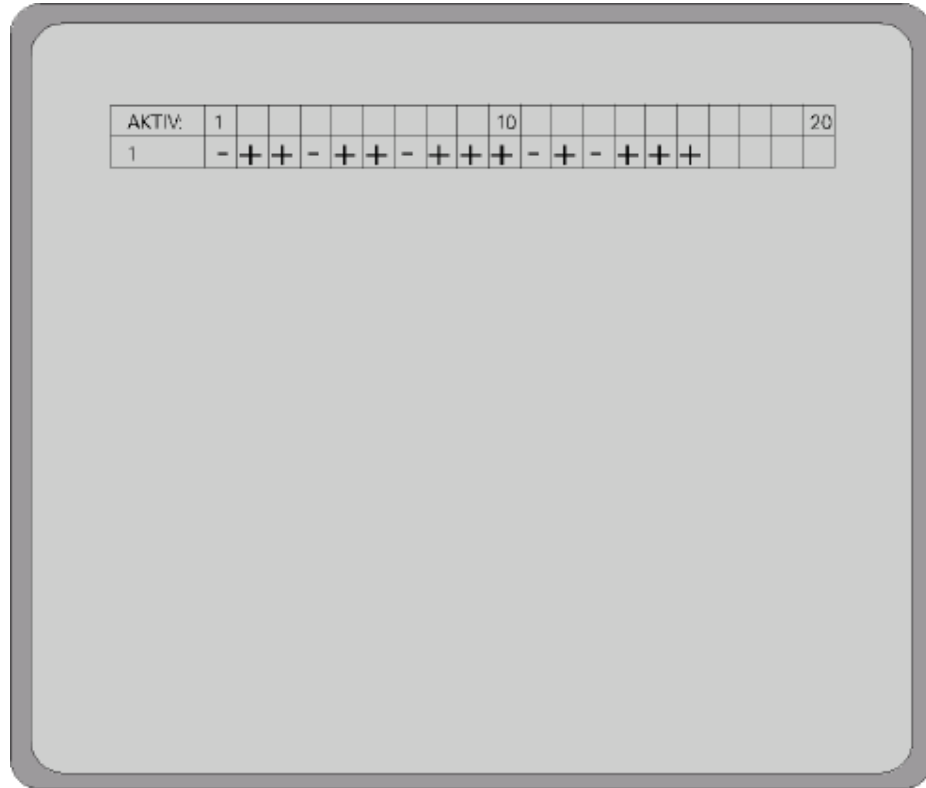
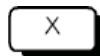

Fig. 37 Detection groups table

Key sequence:



- Enter the number of the detection group that you want to deactivate.
The word **Entry** and the entered number will appear on the monitor.
- Press the **Alarm OFF** key
The monitor displays the table with a minus sign at the side of the activated alarm input.

Deactivating all alarm inputs simultaneously

- Enter **255** and press the **Alarm OFF** key.
The following table appears on the monitor:

| | | | | | | | | | | | | | | | | | | | |
|--------|---|---|---|---|---|---|---|---|---|---|----|---|---|---|---|---|---|---|----|
| AKTIV: | 1 | | | | | | | | | | 10 | | | | | | | | 20 |
| | 1 | - | - | - | - | - | - | - | - | - | - | - | - | - | - | - | - | - | - |

Fig. 38 Detection groups table: all groups deactivated (see programming manual)

5.3 Switching system time to summer/normal time settings

The system time in the SIMATRIX NEO can be switched to summer time, or switched back to normal time. Repeating the key sequence switches between summer and normal time

Key sequence:



You can check that the setting has been changed successfully in the camera text display.

Alternatively, you can use the configuration program to set the system time in the PC connected to the SIMATRIX NEO as the system time in the video matrix unit.

5.4 Resetting and initial system boot

Should the system become inoperable due to programming errors, it can either be reset or rebooted to the delivery configuration, in which alarm program 2 is active.

5.4.1 System reset



All user-defined settings will be lost when a system reset is performed. We recommend that you back-up all configuration data before resetting.

Proceed as follows to reset the system:

- Press the red **Reset** button on the rear of the SIMATRIX NEO for a few seconds, until the message **waiting for CPU** appears in the front display.

Resetting has the same effect as pulling out the mains plug and then turning the device back on.

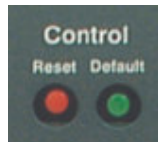

5.4.2 Rebooting the system (to alarm program 2 factory settings)

- Press in and hold down the green **Default** button on the back of the SIMATRIX NEO.
- Next, briefly press the red **Reset** button while keeping the green **Default** button depressed.
The text **waiting for CPU**, followed after a few seconds by **defaults loaded** will appear on the front display.
- Release the green **Default** button.
You have successfully rebooted the system.



Caution

Next, reset the system again using the red **Reset** button, or switch off by pulling out the mains plug and turn the device back on.

6 Maintenance



Danger

When in operation, a number of components in this device are electrically live. Inexpert handling or operation of this device could therefore result in death, severe bodily harm or damage to property. The device may only be serviced and maintained by suitably qualified personnel.
The device must be isolated from the electrical supply before work starts on it.

In the event of breakdown, we recommend you contact your local Siemens branch for service and support.

The mains supply voltages and secondary voltages are fused as follows:

Electrical supply 115 - 230 VAC (+10% / -15%), 50 / 60 Hz, 55 VA max.

Fuses 2 x T 1.6 A 250 V,

6.1 Accessories and ordering information

| Order reference | Short description |
|--------------------|--------------------|
| 2GF2211-8AA | SIMNEO-168 |
| 2GF2211-8AB | SIMNEO-EXT |
| 2GF2211-8CA | SIMNEO-IM |
| 2GF2211-8DA | SIMNEO-OM |
| 2GF2211-8DB | SIMNEO-SOM |
| 2GF2211-8EA | SIMNEO-A128 |

Tab. 12 Accessories and ordering information

7 Appendix

7.1 Technical details

Video

| | |
|---|--|
| Video inputs | BNC sockets U _{ss} =1V video, 75 Ω, with plug-in jumpers and switchable terminations |
| Video outputs | BNC sockets U _{ss} =1V video, 75 Ω |
| Video signal failure recognition | Vertical synchronisation pulse monitoring |
| Text overlay | Complete IBM character set, internal synchronisation, character display: white background, black frame Field size: 12 text lines of 24 characters each Character height: 18 screen lines |
| Cross-talk attenuation | ≥ 56 dB at 5 MHz |
| Differential amplification | ≤ 1 % |
| Differential phase | ≤ 0,6 ° |
| Frequency response characteristic | -0.5 dB at 6 MHz |
| Switching point change-over time after command signal reception at the video matrix | 80 ms (typical), 200 ms (max.) |

Control

| | |
|---|--|
| Control computer | 6 RISC-Controller |
| Interfaces for | |
| - Progr.-PC, IVM-NT, TELEMAT, SIPASS, LMS | 3 x V.24 interfaces Baud rate: 1200 -19,200 bit/s Connection: 3 x 9-pin Sub-D connectors |
| - Keyboards | 8 x TTY(20mA) interfaces with built-in electrical supply for 8 keyboards, (supply max. 800mA total) Cable length: up to 2 km, wire diameter 0.8 mm Baud rate: 1200 -9600 bit/s Connection: 8 x RJ12 sockets |
| - PTZ control (CDC) | 16 x CDC(20mA) interfaces Cable length: up to 2 km, wire diameter 0.8 mm Baud rate: 1200 - 9600 bit/s |
| - Control of Telemetry devices | 4 x RS422/RS485-Ports; Protocols: CCDA, SCU, SIVIS, PELCO-D Connection: 4 x RJ11 –Buchse / Port |
| - Sensor groups Alarm sensors, alarm contacts | 32 x alarm inputs for detection groups Cable length: up to 10 m Connection: 2 x 37-pin Sub-D socket |
| - Video recorder, Picture storage | 8 control outputs (open-collector); max. 30 V, max. 50 mA Relay with 2 voltage-free change-over contacts for collective alarm signalling; max. 48 V, 250 mA; Connection: 1 x 25-pin Sub-D socket |
| Power supply | 115 VAC to 230 VAC, tolerance: +10%/-15% Switching power supply, 50 Hz to 60 Hz The mains socket is fitted with two microfuses (1.6 A slow-blow) |
| Power requirement | Maximum system size: 55 VA per 16 input coupler PCB: 1.4 VA per 8 output coupler PCB: 2.8 VA |
| Operating temperature | + 5 °C to 45 °C |
| Relative humidity | 30 to 85 %, non-condensing |
| Construction | 19 inch chassis, 6 HU |
| Dimensions (w x h x d, chassis without 19"-mount) | 441 x 266 x 217 mm |

It is impossible to describe all the conceivable system architectures, operational situations or repair and maintenance tasks within the confines of this manual.



If you require any further information, or should particular problems arise that are not adequately described in the operating manual, please contact your local Siemens branch for assistance.

Furthermore, we wish to point out that the content of this manual in no way forms a part of, or changes, an earlier or existing agreement, offer or legal relationship. The relevant purchase agreement describes all obligations by which Siemens is bound and the entire scope of the terms and conditions of warranty that apply. These contractual terms and conditions of warranty are neither extended nor limited in any way by the information contained in this operating manual.

7.2 Glossary

| | |
|-------------------------------------|--|
| Alarm image switching | An alarm image appears on the monitor until it is acknowledged |
| Alarm image sequence | All as yet acknowledged alarm images are shown repeatedly in sequence on a monitor |
| Alarm sequence | See alarm image sequence |
| Autoreset | The alarm image disappears from the monitor, as soon as the alarm signal resets. See also <i>manual reset</i> and <i>stack reset</i> |
| Image sequence | Images from several cameras can be switched to a monitor in sequence. The image sequence can be started or stopped by a key on the keyboard. Alternatively, the system can be configured to display preset camera images upon start-up. |
| Dome cameras | Ceiling-mounted, rapid-response, remote control camera with a lens drive system. Housed in a glass dome. |
| CCDA | Siemens dome cameras |
| CCTV | Closed Circuit Television, independent television system in a delimited area |
| External detection group | |
| Group switching | A key on the keyboard is used to switch the images from a camera group to a group of monitors. |
| IVM-NT | Integrated Video Management System |
| LMS | Location planning system |
| Manual reset | As opposed to autoreset. The alarm image remains on display when the alarm signal resets. Alarm events that have already been displayed are overwritten without being stored in memory. See also <i>autoreset</i> and <i>stack reset</i> |
| Pelco D | 3rd party supply dome camera |
| Serial switching, stepped switching | When several alarm images are switched simultaneously, the most recent alarm image is displayed on all monitors in turn. This only applies to monitors that have been configured for alarm image switching. |
| transfer switching | The most recent alarm image is always displayed on the primary monitor (master monitor) in the monitor group. When several alarm images are displayed simultaneously, the less recent images are transferred to the other monitors. |
| SCU protocol | Protocol for controlling telemetry devices |
| SISTORE NT | Image storage system |
| Sivis Minidome | Siemens dome cameras |
| Stack alarm | New alarm images overwrite old alarm images (manual and autoreset) |
| Stack reset | As manual reset, but the alarm events are saved to memory before being overwritten by new alarm events. See also <i>autoreset</i> and <i>manual reset</i> |
| SysLink | Serial system bus. Allows connection of the extension bay and alarm box |
| TELEMAT MD/MTD | Video sensor that recognises motion in the camera image |
| Time-lapse operation | Long-term recording of individual images |

7.3 Summary of basic and alarm program features

| Features | Alarm program 1 | Alarm program 2 Factory setting | Alarm program 4 | Alarm program 5 | Alarm program 3 | Alarm program 6 |
|--|--|--|--|--|--|---|
| Devices | | | | | | |
| Cameras | 1 to 48 | 1 to 48 | 1 to 48 | 1 to 48 | 1 to 48 | 1 to 48 |
| Camera head controls | 1 to 48 | 1 to 48 | 1 to 48 | 1 to 48 | 1 to 48 | 1 to 48 |
| Monitors | 1 to 4 | 1 to 4 | 1 to 4 | 1 to 4 | 1 to 4 | 1 to 4 |
| Keyboards | 1 to 4 | 1 to 4 | 1 to 4 | 1 to 4 | 1 to 4 | 1 to 4 |
| IVM-NT operating stations | 1 to 3 | 1 to 3 | 1 to 3 | 1 to 3 | not recommended for IVM-NT | not recommended for IVM-NT |
| TELEMAT | | | | | not recommended for TELEMAT | not recommended for TELEMAT |
| Basic functions (available without alarm processing) | | | | | | |
| Central dial-up | using keyboard 1 | using keyboard 1 | using keyboard 1 | using keyboard 1 | using keyboard 1 | using keyboard 1 |
| Decentral dial-up | using keyboards 2, 3 and 4 | using keyboards 2, 3 and 4 | using keyboards 2, 3 and 4 | using keyboards 2, 3 and 4 | using keyboards 2, 3 and 4 | using keyboards 2, 3 and 4 |
| Monitor sequencing | on monitors 1 to 4 | on monitors 1 to 4 | on monitors 1 to 4 | on monitors 1 to 4 | on monitors 1 to 4 | on monitors 1 to 4 |
| Camera label | on all monitors | on all monitors | on all monitors | on all monitors | on all monitors | on all monitors |
| Date, time | on a maximum of 8 monitors | on a maximum of 8 monitors | on a maximum of 8 monitors | on a maximum of 8 monitors | on a maximum of 8 monitors | on a maximum of 8 monitors |
| Camera breakdown signal | on all monitors | on all monitors | on all monitors | on all monitors | on all monitors | on all monitors |
| Camera and lens control using CDCs | 48 cameras via a single operating station | 48 cameras via a single operating station | 48 cameras via a single operating station | 48 cameras via a single operating station | 48 cameras via a single operating station | 48 cameras via a single operating station |
| Camera position control | per CDC | pro CDC | pro CDC | pro CDC | pro CDC | pro CDC |
| Alarm processing functions | | | | | | |
| Detector groups | per camera | per camera | per camera | per camera | per camera | per camera |
| Detector groups input configuration | configured for external detector groups(48) | configured for external detector groups(48) | configured for external detector groups(48) | configured for external detector groups(48) | configured for external detector groups(48) | configured for external detector groups(48) |
| Max. no. of alarm images (simultaneous display) | 2 | 2 | 2 | 1 | 4 | 2 |
| Max. no. of alarm events (simultaneous display) | 2 | 2 | 1 | 1 | 4 | 4 |
| Neighbouring camera display | no | no | yes monitor 2 | yes monitor 2 | no | yes monitor 2 monitor 4 |
| Alarm image display | alarm image 1 on monitor 1 alarm image 2 on monitor 2 | alarm image 1 on monitor 1 alarm image 2 on monitor 2 alarm image 3 on monitor 1 etc. | alarm image 1 on monitor 1 and, until acknowledged, on monitor 4. | alarm image 1 on monitor 1 | most recent alarm image (highest number) on monitor 1 next most recent on monitors 2 to 4 | most recent alarm image 1 on monitor 1 alarm image 2 on monitor 3 |
| Most recent alarm image display (transfer/serial switching) | in turn on monitors 1 and 2 | in turn on monitors 1 and 2 | both images simultaneously on monitor 1 and monitor 2 | both images simultaneously on monitor 1 and monitor 2 | last in first out (LIFO) on monitor 1 previous image on monitor 3 transfer switching | last in first out (LIFO) most recent on monitor 1 previous image on monitor 3 transfer switching |
| Switching method (transfer/serial switching) | serial switching | serial switching | serial switching | serial switching | | |
| New alarm images overwrite older images | no | yes | no | yes | yes | yes |
| Mandatory alarm image acknowledgment | yes on monitors 1 and 2 next image on first free monitor | yes on monitors 1 and 2 next image on first free monitor | yes on monitor 1 monitor 2 (neighbouring camera) is also released | yes on monitor 1 monitor 2 (neighbouring camera) is also released | no | no |
| Alarm image sequence | all as yet unacknowledged alarm images on monitor 4 | all as yet unacknowledged alarm images on monitor 4 | all as yet unacknowledged alarm images on monitor 4 | all as yet unacknowledged alarm images on monitor 4 | no | no |

Factory settings Deviation from the factory setting

Diese Zeile muss zwingend die Letzte vor der letzten Seite sein - wird nicht gedruckt - unter "AutoText:" "LastPara" kann sie wieder erstellt werden.

Issued by
Siemens Gebäudesicherheit GmbH & Co. oHG
D-76181 Karlsruhe

www.sbt.siemens.com

© 2005 Copyright by
Siemens Building Technologies AG
Data and design subject to change without notice.
Supply subject to availability.

Printed in the Federal Republic of Germany
on environment-friendly chlorine-free paper.

Document **A24205-A336-A446**
no.
Edition 02.2005